

NUOMI诺米

NUOMI诺米

NUOMI诺米

广东诺米家居智能科技有限公司
GUANGDONG NUOMI HOME INTELLIGENT TECHNOLOGY CO.,LTD

地址：佛山市南海区丹灶镇丹灶物流中心金泰路3号

Address: No.3, JinTai RD, Danzao Town, Foshan City, Guangdong Province, China

电话Tel: 0757-86602177 (总机) 传真Fax: 0757-86602166

服务热线Service Hotline: 400-831-7997 邮政编码Postal Code: 528000

网址Web: aa@gz-nuomi.com 邮箱E-mail: nx02@gz-nuomi.com



公众号



服务号

产品如有改动，请以实物为准 2023年5月第一次印刷

诺米
高端
智能
照明
系统



HIGH-END SMART LIGHTING SYSTEM

诺米高端智能照明系统

SMART LIGHTING SOLUTION

诺米智能照明解决方案

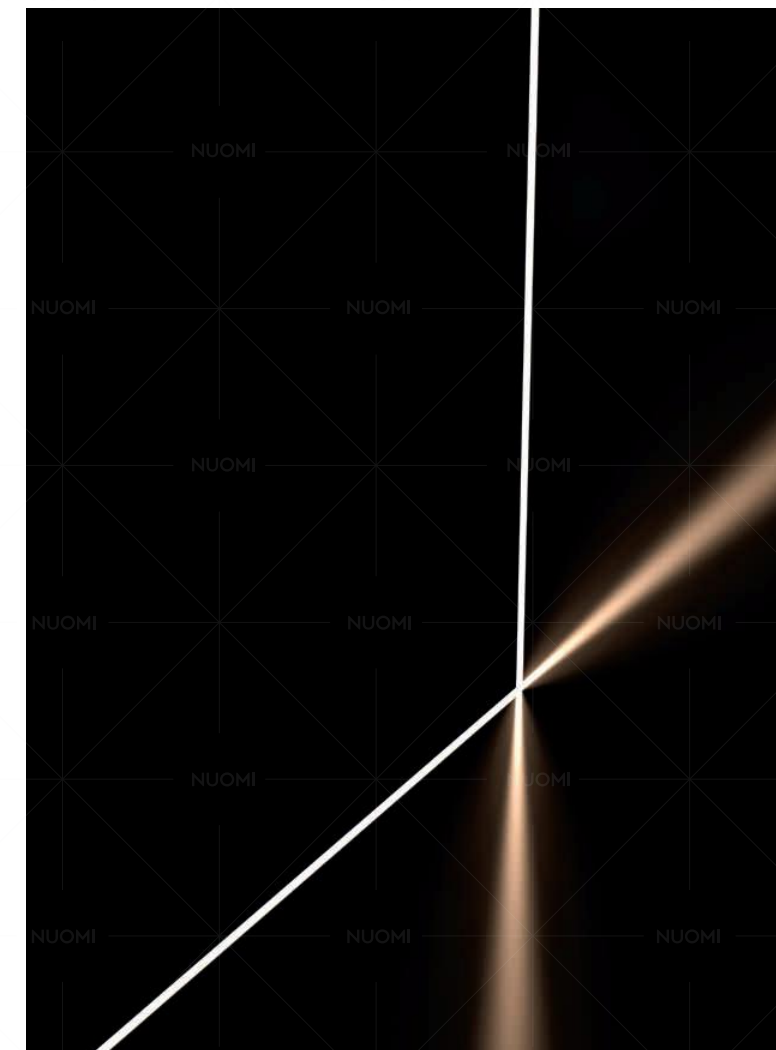

NUOMI 诺米



NUOMI MAKE YOUR HOME LIFE MORE TASTEFUL

诺米 · 让家居生活更有品位!

NUOMI 诺米, 成立 2003 年, 是一家集研发、设计、生产、销售于一体的高新技术企业。

NUOMI, founded in 2003 and is a high-tech enterprise that integrates research and development, design, production, and sales.

作为中国高端家居五金领军品牌之一, 诺米首创并践行「全屋五金生态链」理念, 以同风格、同颜色、同品质、同品牌的“四同法则”实现五金颜值的设计跃级, 并全面布局“橱柜功能五金、衣柜收纳五金、精工水槽、基础五金、智能照明、铝材高定应用”六大产品体系。

As one of China's leading high-end home hardware brands, NUOMI pioneered and practices the concept of "whole-house hardware ecological chain." It uses the "four-same" concept of the same style, same color, same quality, and same brand to achieve design upgrades in hardware aesthetics and has fully laid out six major product systems, including "kitchen storage solutions, wardrobe storage solutions, kitchen sink, furniture motion solutions, smart lighting system and high-end custom aluminum application system."

多年发展以来, 诺米集聚全球研发智慧推出多项创新技术与五金方案, 至今拥有 200 多项创新设计专利, 产品先后通过英国皇冠 ISO9001、瑞士 SGS、德国 TÜV 等国际权威质量检测认证。凭借工业 4.0 智造转型, 诺米在行业内率先打造 80000 m² (I 期) 与 60000 m² (II 期建设中) 智能生产基地, 广泛配备智能机器人、自动化设备、无人仓储系统, 用科技力量赋能五金的柔性化精密生产, 全方位提升交付实力, 并因此斩获“国家高新技术企业”“制造业全国隐形冠军”“家居智造标杆品牌”等多项荣誉。

Over the years, NUOMI has gathered global research and development intelligence and launched many innovative technologies and hardware solutions. It currently holds more than 200 innovative design invention patents and has obtained international authoritative quality certification such as the UK Crown ISO9001, Swiss SGS, and German TÜV for its products. With the transformation of Industry 4.0 intelligent manufacturing, NUOMI took the lead in building an 80,000 square meter (Phase I) and 60,000 square meter (under construction Phase II) intelligent production base in the industry, equipped with intelligent robots, automation equipment, and unmanned storage systems. It uses technology to empower the flexible and precise production of hardware, comprehensively improving delivery capabilities and winning many honors such as "National High-tech Enterprise," "National Invisible Champion of Manufacturing Industry," and "Benchmark Brand of Home Furnishing Intelligent Manufacturing."

通过全方位的能力建构, 诺米成为行业内为数不多能提供一站式、一体化配齐方案的高端全屋五金服务商。截至目前, 面向全球市场的诺米, 现已成为全球众多橱柜品牌和家居品牌的主力供应商, 业务遍及全球 70 多个国家和地区。在中国地区, 诺米与一线上市家居品牌建立战略合作, 全国拥有 200 多个销售服务网点, 品牌实力位居行业前列。

Through comprehensive capacity building, NUOMI has become one of the few high-end whole-house hardware service providers in the industry that can provide one-stop, integrated matching solutions. As of now, NUOMI, which is facing the global market, has become a major supplier to many cabinet and wardrobe brands and home furnishing brands worldwide, with business covering more than 70 countries and regions around the world. In the Chinese market, NUOMI has established strategic cooperation with top-listed home furnishing brands, and its sales network has more than 200 dealers and agents, making it one of the leading brands in the industry.

2023 年, 诺米全新品牌形象焕新而至, 并签约唐嫣为品牌代言人, 开启品牌的跃升新程。

In 2023, NUOMI will unveil a brand new logo and brand image, and signed Tang Yan as the brand spokesperson, opening a new era of brand development.

NUOMI MILESTONE - 诺米里程碑

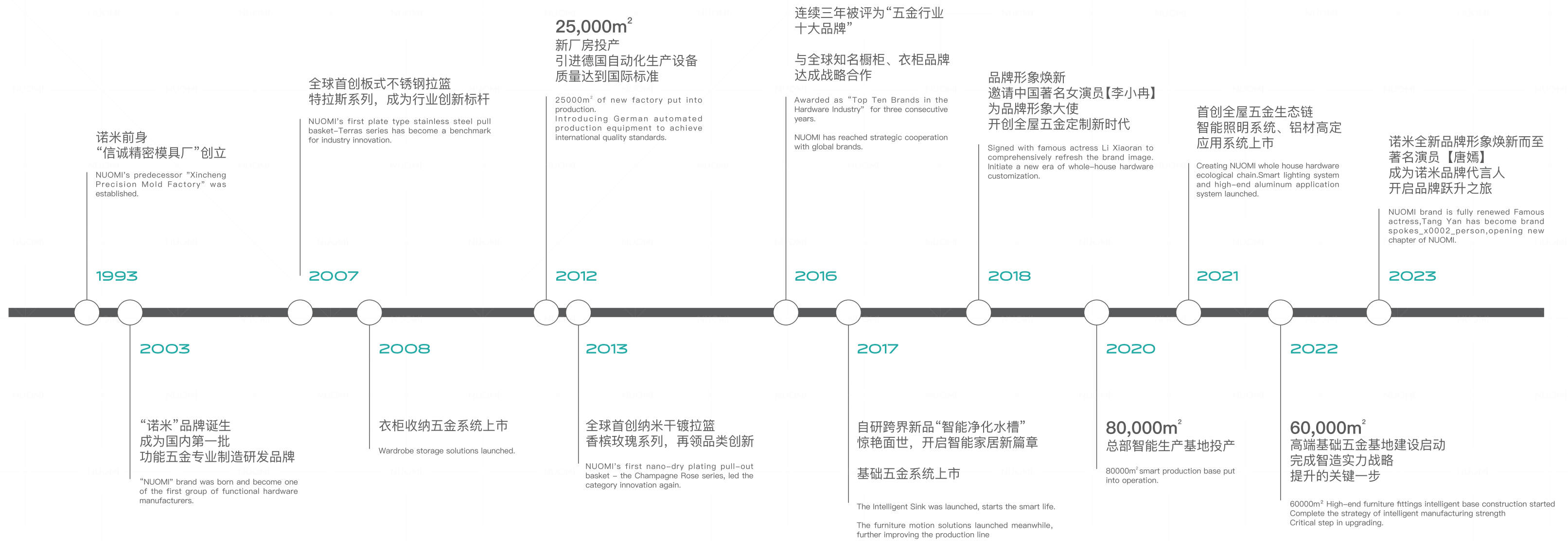

NUOMI 诺米

唐嫣
诺米全屋五金品牌代言人

「嫣」值美家
共同奔赴

橱柜功能五金系统 KITCHEN STORAGE

衣柜收纳五金系统 WARDROBE STORAGE

精工水槽系统 KITCHEN SINK

基础五金系统 CONNECTIVE MOTION HARDWARE

智能照明系统 SMART LIGHTING

铝材高定应用系统 ALUMINUM APPLICATION

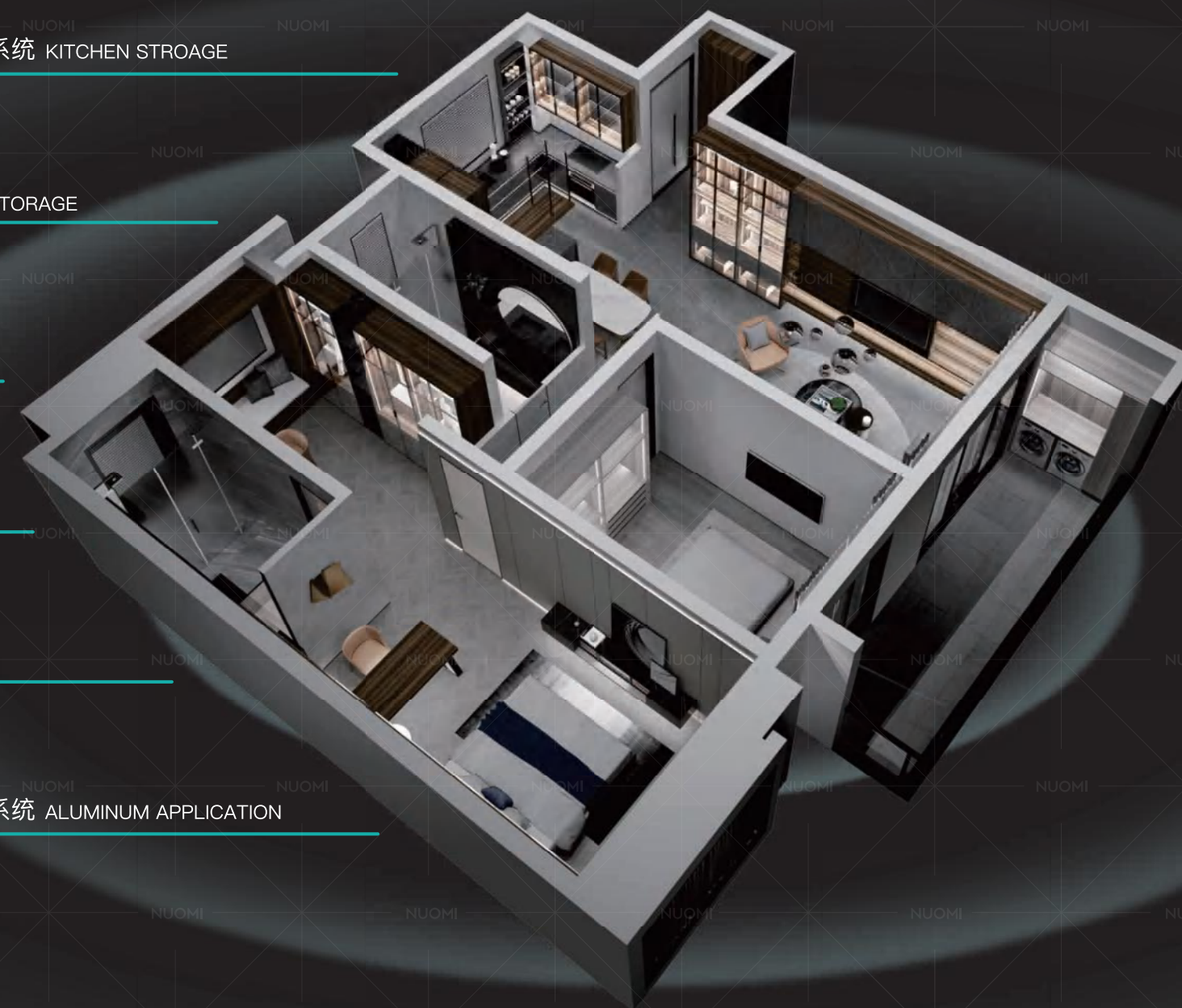

DESIGN CONCEPT

四同法则



同[风格]

极简轻奢贯穿全屋五金设计,美学风格协调统一,实现整家搭配的审美提升。

SAME STYLE

Minimalist light luxury runs through the hardware design of the whole house,coordinated aesthetic style, realize the aesthetic improvement of the whole home collocation.

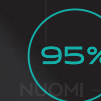

同[颜色]

全屋五金不同配件保持同一色系,同色率达95%以上,满足高定家居的细节要求。

SAME COLOR

Keep the same color system for different hardware accessories in the whole house,the same color rate is over 95%,meet the detailed requirements of high-end home furnishing.

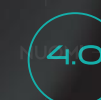

同[品质]

全屋五金由诺米4.0基地制造出厂,数智化、自动化产线高标交付,7级质检把控产品一致性。

SAME QUALITY

The whole house hardware is manufactured by NUOMI 4.0 production base, the factory is digitized and automated. The production line is delivered with high standards and 7 levels of quality inspection to control product consistency.



同[品牌]

全屋五金无需东拼西凑,诺米全系自研自产,多品类一站省心配套。

SAME BRAND

The whole house hardware does not need to be pieced together,NUOMI full system products are self-developed and self-produced, multi-category one-stop worry-free support.

NUOMI DESIGN - 诺米设计

诺米基于极简主义“少即是多 (Less is more)”的设计哲学,以全屋产品体系、至臻工艺细节、全球高阶审美,顺势推出“四同法则”,为全屋五金融入轻奢范式,满足更高阶奢居的定制所需。

NUOMI is based on the design philosophy of “Less is more”, and with a complete home product system, exquisite craftsmanship details, and global high-end aesthetics, it has launched the “Four-Same” concept to integrate whole house hardware into a minimalist and luxurious paradigm, meeting the needs of high-end custom homes.

全屋五金 整家奢配

Whole house hardware
the whole house is luxuriously matched.

6 大品类
6 major categories

独立研发团队“赛马”式创新
Independent R&D team with "orse racing" style innovation.

200+ 项

创新设计专利改进产品使用体验
Innovative design patents improve the user experience of the product.

3000+ 个
3000 items

产品 SKU 满足细分需求
Product SKU meet specific segmentation demands.

科技智造 双擎加速

Intelligent manufacturing with technology
dual-engine acceleration.

80000 m²

国际 4.0 数智化生产基地
International Industry 4.0 digital intelligence production base.

60000 m²

高端基础五金智造基地
The high-end furniture motion intelligent manufacturing base.

2014–2016 连续三年被评为“五金行业十大品牌”

2019 年 荣获国家级《高新技术企业证书》

2021 年 被全国工商联家具装饰业商会评为《中国家居优选供应链百强》

2021 年 被全国工商联家具装饰业商会评为《战略合作伙伴》

2022 年 被评为南海制造业全国隐形冠军

2022 年 斩获“家居智造标杆品牌”、“设计创新奖”、“技术领先奖”

2022 年 入选佛山市专精特新企业

2022 年 认定为佛山市高端全屋定制五金（诺米家居）工程技术研究中心

Was rated as "Top Ten Brands in the Hardware Industry" for three consecutive years from 2014 to 2016

Won the national "high-tech enterprise certificate" in 2019

Was rated as "Top 100 Chinese Home Furnishing Supply Chain Companies" by the China Furniture & Decoration Chamber of Commerce in 2021

Was rated as "Strategic Partner" by China Furniture & Decoration Chamber of Commerce in 2021

Named the National Invisible Champion of Nanhai Manufacturing Industry in 2022

Won the "Benchmark Brand of Smart Home Manufacturing", "Design Innovation Award", and "Technology Leadership Award" in 2022

Selected as a Specialized and Innovative New Enterprise in Foshan in 2022

Identified as Foshan High-end Customization of Whole House Hardware (Nuomi Home) Engineering Research Center in 2022



诺米智能生产基地 II 期
NUOMI intelligent production base phase II



尖端 CNC 精密加工中心
Cutting-edge CNC precision machining center



激光切割自动化产线
Laser cutting automatic production line



诺米智能生产基地
NUOMI Intelligent Production Base



智能无人立体仓库
Intelligent unmanned three-dimensional warehouse



全自动焊接机械臂
Fully automatic welding robot arm

0.01

0.01cm 精控误差，追求卓越品质的产品契合。
0.01Cm precision control pursue excellent quality.

3

3 重国际权威品质认证，英国 ISO+ 瑞士 SGS+ 德国 TÜV。
3 international authoritative organization for quality certification:
ISO, SGS, TÜV

7

7 级质检把控，从原料到成品，每一件产品历经层层检测，严控质量是诺米
提供给消费者的可靠性保证。
7 level quality control, from raw materials to finished products, each
product after layers of testing, strict quality control is the reliability
guarantee that NUOMI provides to consumers.

10

导轨 10 年至终身质量保障，让用户时刻无忧。
Slide-10 Years quality assurance, reassure users.

168

纳米干镀表面处理技术，通过 168 小时盐雾测试，持久光亮不生锈。
Dry-plating technology, pass 168 hours salt spray test,
lasting bright and rust-resistant.

80000

导轨通过 SGS 80000 次抗疲劳运作测试，安心更舒心。
Slide pass SGS 80000 anti-fatigue operation test, more comfortable.



高新技术企业证书
Hi-tech Corporate Certificate



获英国皇冠 ISO9001 质量管理认证
ISO9001 Quality Management
System Certification



德国 TÜV 质量检测认证
Quality Testing Certification



瑞士 SGS 质量检测认证
Quality Testing Certification

SALES NETWORK – 诺米全球营销网络

是中国的诺米，更是世界的诺米。依托全球化的服务体系，诺米长期为数百个国内外知名橱柜品牌、家居品牌提供五金解决方案，产品畅销亚洲、欧洲、北美洲等全球 70 多个国家和地区，占有国际中高端市场一席之地。

NUOMI is not only a Chinese brand, but also a global brand. With a globalized service system, NUOMI has long provided hardware solutions for hundreds of international kitchen cabinet and home furnishing brands. Its products are sold in more than 70 countries and regions around the world, including Asia, Europe, and North America, and have a leading position in the international high-end market.

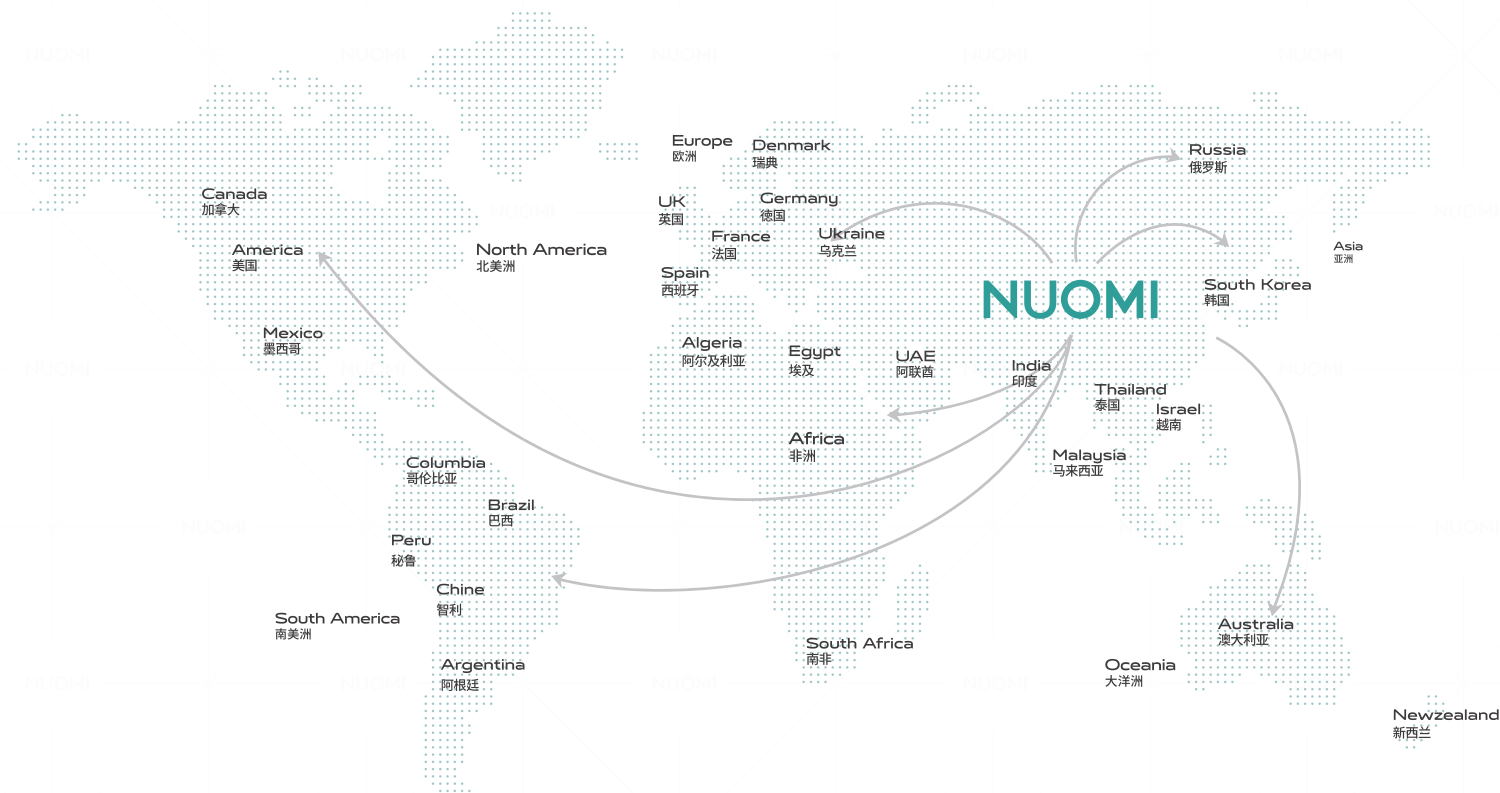

STAINLESS STEEL SINK – 全球网络布局

ASIA 亚洲

- China 中国
- Malaysia 马来西亚
- Israel 以色列
- Vietnam 越南
- Thailand 泰国
- Saudi Arabia 沙特阿拉伯
- UAE
- Singapore 新加坡
- India 印度
- South Korea 韩国
- Mongolia 蒙古

EUROPE 欧洲

- Austria 奥地利
- Ukraine 乌克兰
- Germany 德国
- Denmark 瑞典
- France 法国
- Denmark 丹麦
- Italy 意大利
- Finland 芬兰
- Spain 西班牙
- Norway 挪威
- UK 英国
- Greece 希腊
- Russia 俄罗斯
- Poland 波兰
- Portugal 奥地利

AFRICA 非洲

- South Africa 南非
- Algeria 阿尔及利亚
- Egypt 埃及

NORTH AMERICA 北美洲

- Mexico 墨西哥
- America 美国
- Canada 加拿大

SOUTH AMERICA 南美洲

- Columbia 哥伦比亚
- Peru 秘鲁
- Brazil 巴西
- Chine 智利
- Argentina 阿根廷

OCEANIA 大洋洲

- Newzealand 新西兰
- Australia 澳大利亚



在中国地区，诺米与一线上市家居品牌建立战略合作，拥有的 200 多个销售服务网点遍布全国城市圈。

In China, NUOMI has established strategic partnerships with first-tier listed home furnishing brands, and its sales network includes more than 200 distributors and agents covering cities across the country.





TECHNOLOGY GUIDANCE 技术指引

LIGHT 光源



高品质密集发光芯片升级设计，严选晶元芯片，光效柔和均匀无点光；全盘满锡工艺，抗氧化耐高温，保证品质稳定可靠。

Upgraded design of high-quality dense light-emitting chips, carefully selected wafer chips, soft and uniform light effect without spot light; full tin process, oxidation resistance and high temperature resistance, ensuring stable and reliable quality.



好芯片塑造星级光效，显示指数 $\geq 90Ra$ ，高度还原被照物体本色，有效减少色差。

A good chip creates a star light effect, with a display index $\geq 90Ra$, which can highly restore the original color of the illuminated object and effectively reduce chromatic aberration.



分光标准根据国际 ANSI 标准进行设定，保证不同批次出货产品光色一致。

The spectroscopic standard is set according to the international ANSI standard to ensure that the light color of different batches of products is unified.



提供 3 种标准色温选择，以满足不同用户的需求。

Provide 3 standard color temperature options to meet the needs of different users.



通过 LM-80 测试认证，使用寿命高达 70000 小时，保证使用 35000 小时情况下，流明维持率在 80% 以上。

Passed LM-80 test certification, the service life is as high as 70,000 hours, and the lumen maintenance rate is over 80% after 35000 hours usage.



LED 灯带导电路板采用 2 盎司压延铜双面板，有更强的柔韧性，更好的导电和散热能力。

The LED light strip conductive circuit board uses 2 ounces of rolled copper double-sided board, which has stronger flexibility, better conductivity and heat dissipation capacity.



采用正品美国 3M 公司背胶，粘合力强，久用不易脱落。

Adopting genuine American 3M company back glue, it has stronger adhesiveness and is not easy to fall off after long use.

ALUMINUM PROFILE 铝型材



选用高品质铝材，成型后通过时效淬火，大幅度提升性能，增加硬度与韧性，使其不易变形。

High-quality aluminum, through aging quenching after forming, greatly improves performance, increases hardness and toughness, and makes it difficult to deform.



铝型材水性氟碳喷涂工艺，使用水性氟碳环保漆安全更环保，卓越的抗沾污性，理想的耐洗刷性，优异的耐化学性，良好的耐盐雾性。

Aluminium profile, waterborne fluorocarbon coating technology, more safe and environmental, excellent stain-resistance, brilliant brush resistance, outstanding chemical resistance, good resistance to salty fog.

LAMP SHADE 灯罩



采用高品质 PC 材料，抗 UV，制成的灯罩光线分散均匀无晶点，柔和不刺眼。

The lampshade is made of high-quality PC material, Anti-UV, and the light of the lampshade is evenly dispersed and has no crystal points, which is soft and not dazzling.

POWER SUPPLY 电源



电源全系 16.5mm 超薄设计，易于隐藏，使柜内空间得到更充分的利用。

The power supply is 16.5mm ultra-thin design, easy to conceal, make better use of space.



可便捷无线安装，无走线顾虑。支持无线触摸感应、无线人体感应、无线门控或手扫（集成可切换）感应开关。

Can be installed wirelessly without concerns about wiring. Support wireless touch sensing, wireless human sensing, wireless gating or hand sweeping (integrated switchable) sensor switch.

INDEX - 目录



灯光创意定制系列
LIGHT CREATIVE CUSTOMIZATION

P.023

宙斯系列
ZEUS LIGHT

P.037

洛克斯系列
ROCKS LIGHT

P.069

阿瑞斯系列
ARES LIGHT

P.097

感应式灯光系列
INDUCTIVE LIGHT

P.111

常规灯光系列
COMMON LIGHT

P.125

智能控制系统及配件
SMART CONTROL SYSTEM

P.135

ARTISTIC INTERPRETATION

LIGHT CREATIVE CUSTOMIZATION

灯光创意定制

NUOMI explores the light perception of the living environment, gathers design aesthetics, and can provide creative home lighting solutions according to the needs of different users, tailor-made exclusive spaces, and create a warm and elegant livable environment.

诺米探索人居环境光感，汇聚设计美学，可以根据不同用户的需求，提供具有创意的家庭灯光解决方案，量身定制心动专属空间，打造温馨而优雅的宜居环境。





LIGHT CREATIVE CUSTOMIZATION

灯光创意定制



NUOMI lighting concept brings more personal experience and comfort to life, forms the use of artistic visual expression, leads lifestyles, meets high-end needs, and finds the most suitable lighting products for your home.

诺米灯光理念为生活带来更多个性体验与舒适，
形成艺术感的视觉表达的使用感受，引领生活方式，满足高端需求，
为你的家居找到最合适的灯光产品。



CUSTOMIZED, JUST TO BE RIGHT

Choose the appropriate size and light color according to different places of use to meet the lighting needs of the home, the space is clear, and the ideal visual effect is achieved.

定制，只为恰到好处

根据不同的使用场所选择合适的尺寸和光色，满足家居的照明需求，空间清晰明朗，达到理想中的视觉效果。





产品特点 FEATURES

- 采用高品质 LED 光源，可调或可选色温（3000K、4000K、6000K），可调亮度，出光均匀，70000 小时超长寿命，内置 12V 恒压驱动电源；
- 直接固定墙面安装便捷，简约轻奢，插入式交流电 220VAC；
- 优质铝合金，承重力强，铝型材水性氟碳喷涂工艺；
- 显指 Ra>90。

- Adjustable or optional color temperature (3000K、4000K、6000K) , adjustable brilliance, lighting balance, service life over 70000 hours, with transformer.
- Easy to install, plug-in alternating current 220VAC.
- Anodised aluminium, strong loadbearing, aluminium profile, waterborne fluorocarbon coating technology.
- Ra>90.

可调灯源色温 COLOR TEMPERATURE ADJUSTABLE



安装说明 INSTALLATION INSTRUCTIONS

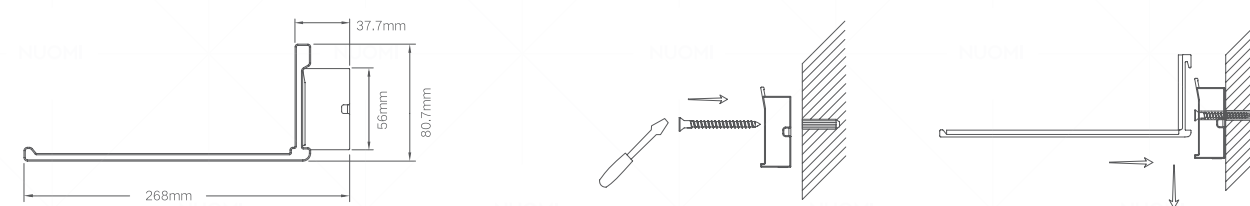

技术参数 TECHNICAL DETAILS

Color Temperature 色温 (K)	Item No. 型号	Size (mm) 尺寸 (mm)	Power 功率	Sensor switch 感应开关		
可调色温 (3000K、4000K、6000K)	Bordeaux red 波尔多红	Champagne golden 香槟金	Highclass grey 太郎灰			
	12110061	12110062	12110063	600mm	12W	
	12110091	12110092	12110093	900mm	18W	带皮革 (内置电源, 带开关)
3000K	12110121	12110122	12110123	1200mm	24W	
	12113061	12113062	12113063	600mm	12W	
	12113091	12113092	12113093	900mm	18W	
	12113121	12113122	12113123	1200mm	24W	不带皮革 (内置电源, 不带开关)
	12113001	12113002	12113003	定制尺寸 custom size	20W/m 米	
4000K	12114061	12114062	12114063	600mm	12W	
	12114091	12114092	12114093	900mm	18W	
	12114121	12114122	12114123	1200mm	24W	不带皮革 (内置电源, 不带开关)
	12114001	12114002	12114003	定制尺寸 custom size	20W/m 米	

★ 电压：220VAC，连接方式：AC 插头线（1.2M）。AC plug with cords (1.2M)。



产品特点 FEATURES

- 采用高品质 LED 光源，可调色温（3000K、4000K、6000K）、亮度，出光均匀，70000 小时超长寿命；
- 直接固定墙面安装便捷，简约轻奢，插入式交流电 220VAC；
- 优质铝合金，承重力强，铝型材水性氟碳喷涂工艺；
- 显指 Ra>90。
- Adjustable light color temperature and brilliance, lighting balance, service life over 70000 hours.
- Easy to install, plug-in alternating current 220VAC.
- Anodised aluminium, strong loadbearing, aluminium profile, waterborne fluorocarbon coating technology.
- Ra>90.

可调灯源色温 COLOR TEMPERATURE ADJUSTABLE



安装说明 INSTALLATION INSTRUCTIONS

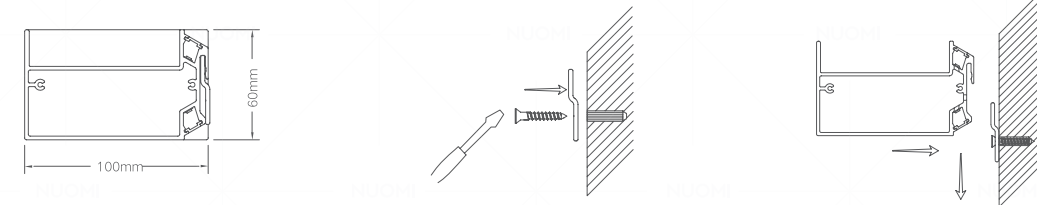

技术参数 TECHNICAL DETAILS

Color Temperature 色温 (K)	Item No. 型号		Size (mm) 尺寸 (mm)	Power 功率	Sensor switch 感应开关	
可调色温 (3000K、 4000K、6000K)	Bordeaux red 波尔多红	Champagne golden 香槟金	Highclass grey 太郎灰	600mm	12W	内置无线触摸调光感应开关 (内置 12V 恒压驱动电源) built-in wireless touch sensor switch for light adjustment (with 3C power source)
	12120061	12120062	12120063	900mm	18W	
	12120091	12120092	12120093	1200mm	24W	
	12120121	12120122	12120123	定制尺寸 custom size	20W/米	
	12120001	12120002	12120003			

★ 电压：220VAC，连接方式：AC 插头线（1.2M）。AC plug with cords (1.2M)。

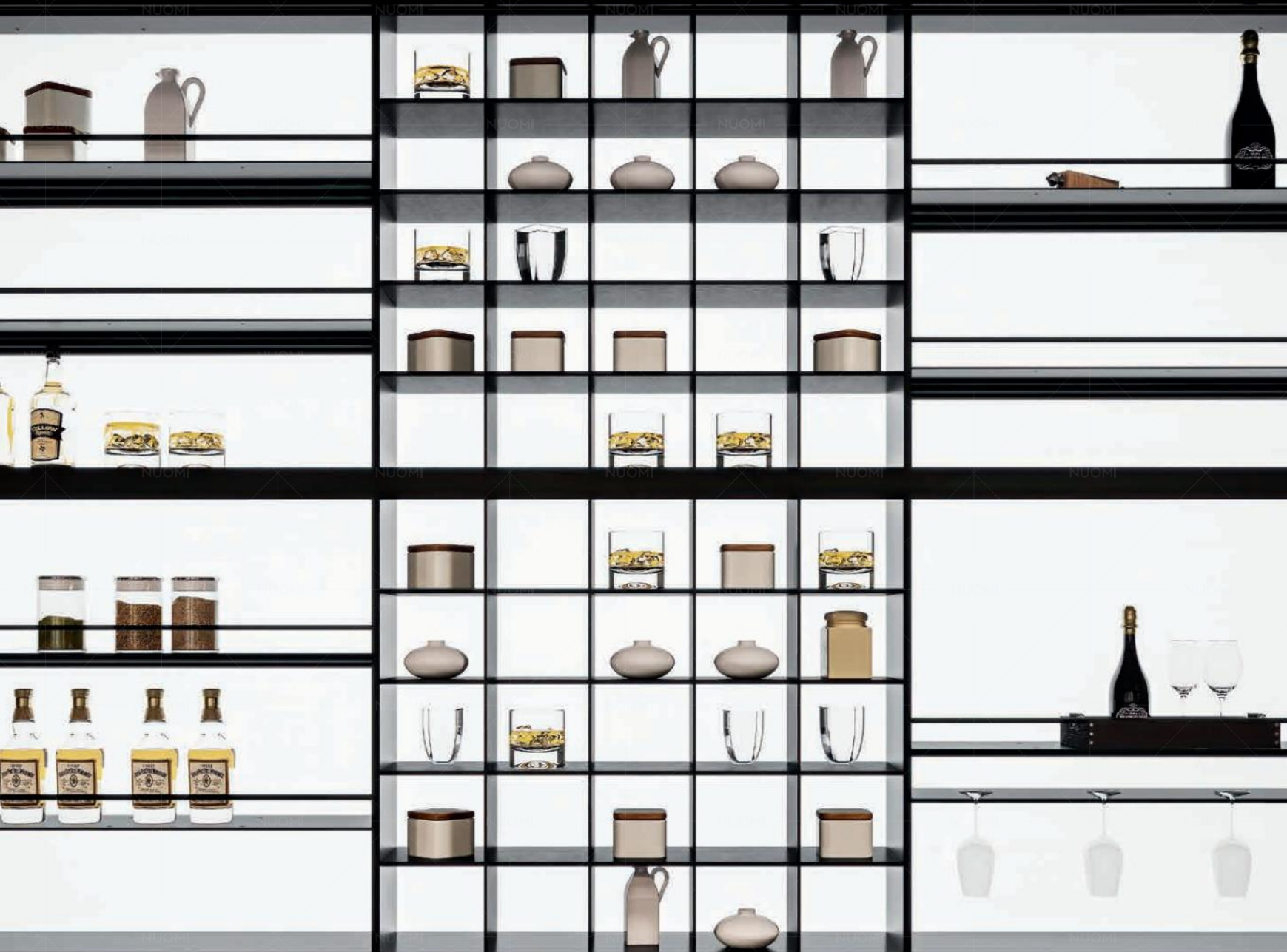

产品特点 FEATURES

- 采用高品质 LED 光源，可调色温（3000K、4000K、6000K）、亮度，出光均匀，70000 小时超长寿命；
- 日本进口三菱导光板出光，整面发光均匀无光斑；
- 定制尺寸，直接嵌入柜体，简约轻奢；
- 优质铝合金，承重力强，铝型材水性氟碳喷涂工艺；
- 显指 Ra>90。

- Adjustable light color temperature and brilliance, lighting balance, service life over 70000 hours.
- LGP imported from mitsubishi of Japan, lighting balance.
- Customized size, embedded cabinet, plugin alternating current voltage.
- Anodised aluminium, strong loadbearing, aluminium profile, waterborne fluorocarbon coating technology.
- Ra>90.

可调灯源色温 COLOR TEMPERATURE ADJUSTABLE



技术参数 TECHNICAL DETAILS

Color Temperature 色温 (K)	Product Name 产品名称	Item No. 型号	Size (mm) 尺寸 (mm)	Power 功率	Sensor switch 感应开关		
可调色温 (3000K、 4000K、6000K)		Bordeaux red 波尔多红	Champagne golden 香槟金	Highclass grey 太即灰	Matte black 哑黑		
	厨房灯光开架基础款 Basic set	12130111	12130112	12130113	12130115	定制尺寸 custom size	10W/m 米
	厨房灯光开架带十字格款 Basic+cross rack set	12130121	12130122	12130123	12130125	定制尺寸 custom size	10W/m 米 不含电源和感应器 exclude power source and sensor switch
	厨房灯光开架带酒杯架款 Basic+glass shelf set	12130131	12130132	12130133	12130135	定制尺寸 custom size	10W/m 米
	厨房灯光开架基础款 Basic set	12130211	12130212	12130213	12130215	定制尺寸 custom size	10W/m 米 不含电源和感应器 exclude power source and sensor switch
	厨房灯光开架带十字格款 Basic+cross rack set	12130221	12130222	12130223	12130225	定制尺寸 custom size	10W/m 米 含 5mm 导光背板 Include 5mm LGP
	厨房灯光开架带酒杯架款 Basic+glass shelf set	12130231	12130232	12130233	12130235	定制尺寸 custom size	10W/m 米
	厨房灯光开架带轨道电源款 Basic-cross rack set	12130141	12130142	12130143	12130145	定制尺寸 custom size	10W/m 米
	厨房灯光开架带轨道电源款 Basic-glass shelf set	12130241	12130242	12130243	12130245	定制尺寸 custom size	10W/m 米 含 5mm 导光背板 Include 5mm LGP

Module Of Product
产品模块

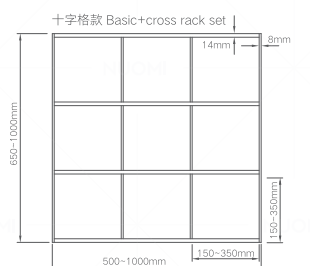
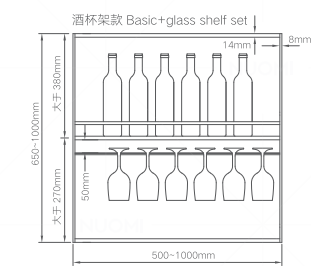
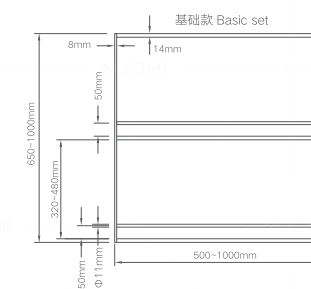

Design Reference
设计组合参考

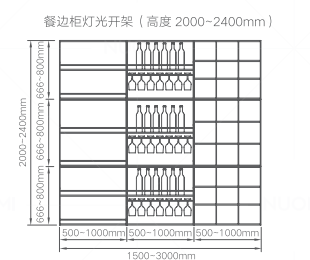
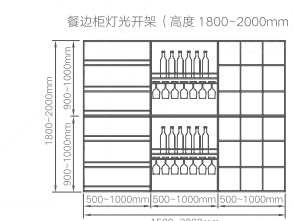
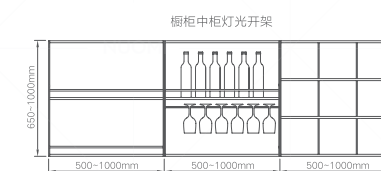

备注:

1. 开架灯基础款、格子款外形尺寸 (长) 500-1000mm (高) 650-1000mm; 酒杯架款外形尺寸 (长) 500-1000mm (高) 700-1000mm;
2. 开架灯层高、格子尺寸没有注明高度、宽度时, 按外形尺寸均分;
3. 开架灯上的圆杆、酒杯架距离层板的尺寸为 50mm。

★ 电压: 220VAC, 连接方式: AC 插头线 (1.2M)。AC plug with cords (1.2M)。

AGAIN DEFINITION

ZEUS SERIES

宙斯系列

The simple design elements are organically arranged and integrated, and the concise line guidance allows the vision to be stretched vertically and at the same time, with the art of light and shadow, redefine the space.

简单的设计元素进行有机的编排、整合，简练的线条引导，让视觉有了纵向的拉伸同时，配合光影艺术，重新定义空间。

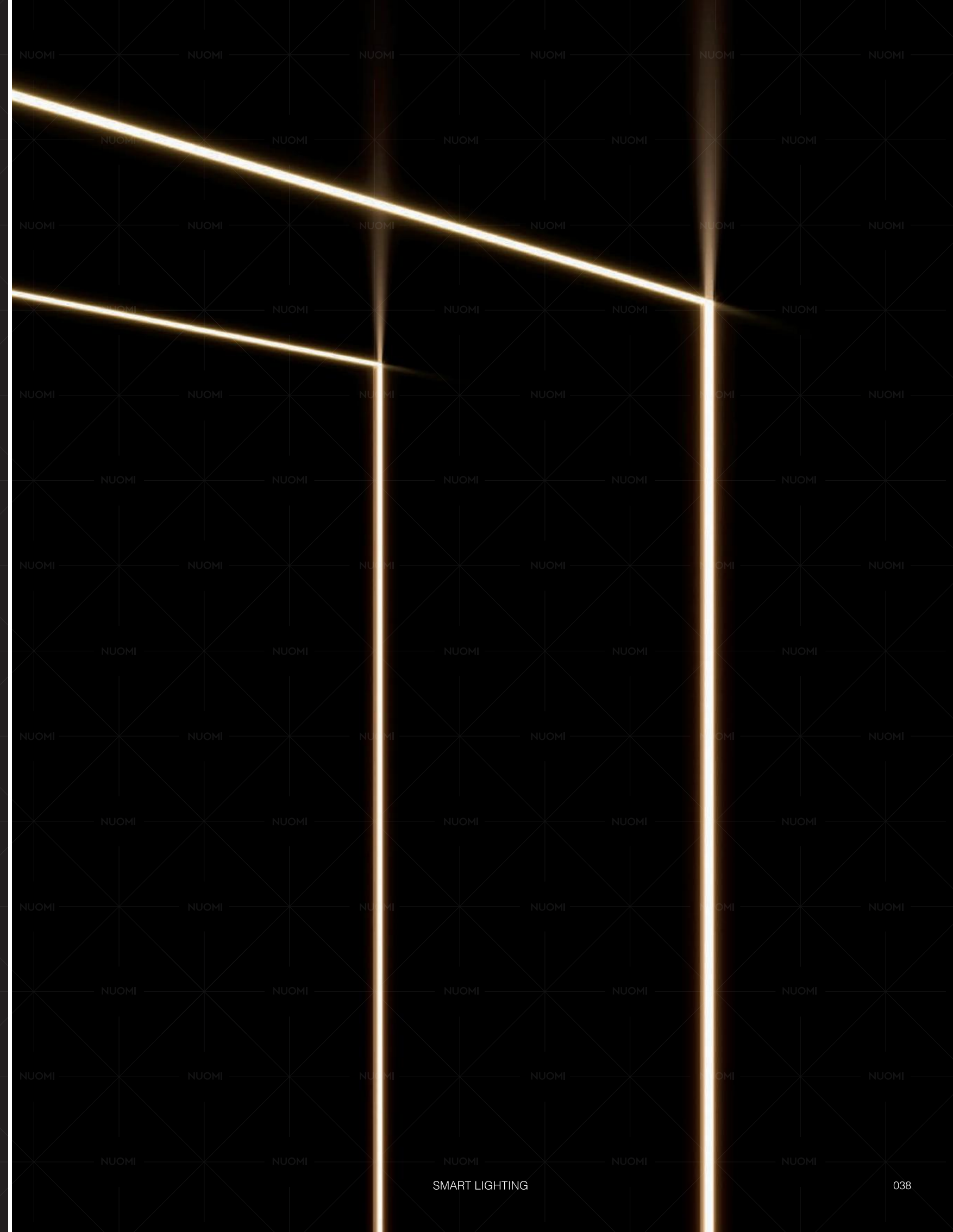



ZEUS LIGHT

宙斯系列

It comes with a soft filter effect to create a sense of intimacy and form an active atmosphere. With the adjustment of low light, the sense of warmth slowly rises, and the space becomes full and beautiful.

自带柔和的滤镜效果，塑造亲和感，形成活跃的氛围调动，微光的调和下，温馨感缓缓而升，空间变得饱满而美妙。

GOOD CHIP SHAPES STAR LIGHT EFFECT
好芯片塑造星级光效

全盘满锡工艺，杜绝触点氧化

- 导电轨道全盘满锡工艺，杜绝氧化，安全放心
- 72h 盐雾测试，耐腐蚀耐高温

72 hours

NUOMI

显色指数

≥ 90Ra

Color rendering index ≥ 90Ra
Strictly selected wafer chips, soft and uniform light effect

严选晶元芯片，光效柔和均匀

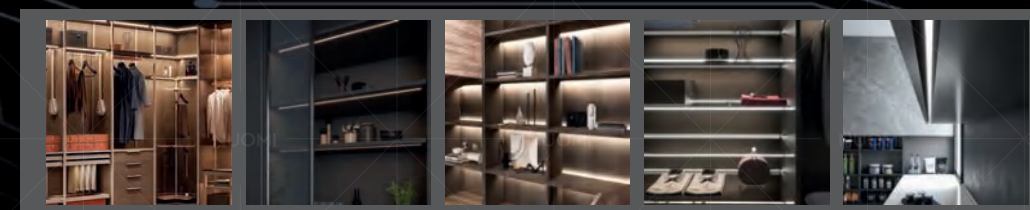

耀眼出色，不止一种
百搭空间设计，营造多样氛围

TEN CORE SELLING POINTS 十大核心卖点



升级密集发光芯片设计
UPGRADE DENSE LIGHT-EMITTING
CHIP DESIGN

- 300 颗密集发光芯片升级设计，灯光饱和度高，180°出光角，出光均匀整灯无暗区无点光；
- 好芯片塑造星级光效，严选晶元芯片，光效柔和均匀，显色指数 ≥ 90Ra，高度还原被照物体本色，有效减少色差。
- Upgraded design of 300 dense light-emitting chips, high light saturation, 180° light angle, uniform light output, no dark areas and no spots;
- Good chips create star light effects, carefully selected epistar chips, soft and uniform light effects, color rendering index ≥ 90Ra, highly restore the original color of the illuminated object, and effectively reduce color difference.



低蓝光伤害
LOW BLUE LIGHT DAMAGE

- 无频闪光学设计，如自然光般细腻柔和，呵护你和家人的清晰视界。
- The frequency-free optical design is as delicate and soft as natural light, protecting the clear vision of you and your family.



诺米独家专利免焊技术
NUOMI'S EXCLUSIVE PATENTED
WELDING-FREE TECHNOLOGY

- 升级 U 型 AB 线镀金触点与全锡焊盘精准对接，仿拉锁设置，弹性好适用性更强，插头稳定不松脱；
- 隐藏式防拉锁设置，线材拉力达 2.5N；
- 加长锁定弹片，插拔更方便，锁定更容易；
- 采用德国巴斯夫材料，适用性更广、稳定性更高。
- Upgraded U-shaped AB wire gold-plated contacts are precisely docked with all-tin pads, imitation pull lock settings, good elasticity and stronger applicability, and the plug is stable and not loose;
- Hidden anti-pull lock setting, wire tension up to 2.5N;
- Lengthened locking shrapnel, more convenient to plug in and pull out, easier to lock;
- Using German BASF materials, wider applicability and higher stability.



高精密度喷锡电镀板
(灯带里导线条)
HIGH-PRECISION TIN-SPRAYED
ELECTROPLATING BOARD
(WIRE STRIP IN THE LIGHT STRIP)

- 高精密度电路板，采用全盘满锡工艺，通过 72h 盐雾测试，抗氧化耐高温，寿命长。
- High-precision circuit board, using the technology of full tin, passed the 72h salt spray test, resistant to oxidation and high temperature, and long service life.



同一端子应用多种型材
MULTIPLE PROFILES FOR THE
SAME TERMINAL

- 践行诺米全屋五金同色理念，免焊同色堵头不露白；
- 同一端子适用多种型材，满足各种家居装饰风格。
- Be consistent of NUOMI's concept of keeping whole-house hardware in the same color.;
- The same terminal is suitable for a variety of profiles to meet various home decoration styles.



灵活裁剪随心定制
FLEXIBLE CUTTING AND
CUSTOMIZATION

- 导电轨道灵活裁剪个性定制，用户可根据空间使用需求自行裁剪；
- 让发光不再受限制，导电轨道全喷无铅锡工艺，杜绝氧化，安全放心。
- The conductive track can be flexibly cut and customized, and users can cut it according to the needs of space use.
- The light is no longer limited, the conductive track is fully sprayed with lead-free tin technology, to prevent oxidation, to be safer.



耀眼出色，不止一种
DAZZLING, MORE THAN ONE

- 3000k / 4000k 两种光色可选，百搭空间设计，营造多样氛围；
- 暖黄光 - 打造温馨居室，自然光 - 增添几分精致感。
- 3000k / 4000k two light colors are optional, versatile space design, creating a variety of atmospheres;
- Warm yellow light - to create a warm living room, natural light - to add a sense of sophistication.



多模态电源控制系统
MULTIMODAL POWER CONTROL
SYSTEM

- 本品可结合不同的应用场景，搭配合理的控制方案：手扫 | 门控 | 红外线 | 语音
- 12V 安全低压国际安全标准，防触电设计，安全省心
- This product can be combined with different application scenarios, with a reasonable control scheme: hand scan | door control | infrared | voice;
- 12V safe low-voltage international safety standard, anti-shock design, safe and reassuring.



卡扣式快装快拆结构
BUCKLE TYPE QUICK
INSTALLATION AND QUICK
RELEASE STRUCTURE

- 卡扣式快装快拆结构，解决繁琐安装痛点，稳固牢靠经久耐用。
- The snap-on quick-installation and quick-disassembly structure solves the pain points of cumbersome installation, and is stable, reliable and durable.



3 米半成品出货
3 METERS OF SEMI-FINISHED
PRODUCTS SHIPPED

- 灯带、型材、PC 面罩组装半成品出货，操作更简单，效率更高。
- Light strips, profiles, and PC lampshade are assembled and shipped as semi-finished products, which is easier to operate and more efficient

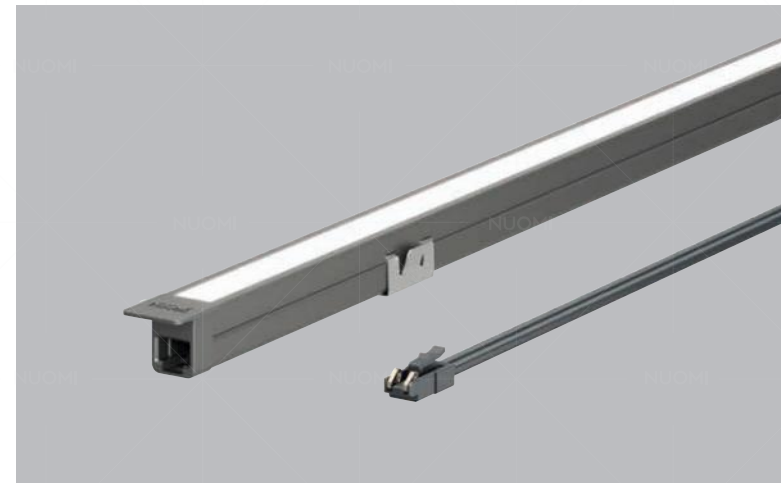

产品特点 FEATURES

- 升级密集发光芯片设计, 可调或可选色温 (3000K、4000K) 柔和细腻流光, 无频闪不伤眼;
- 插入式灯线分离技术, 隐藏式防拉锁定设置, 适用性更广、稳定性更高;
- 高精度电路板, 全盘满锡工艺, 抗氧化耐高温, 寿命长;
- 灵活裁剪随心定制, 导电轨道全喷无铅锡工艺, 杜绝氧化;
- 卡扣式快装快拆结构, 操作更简单, 效率更高。

- Adjustable or optional color temperature(3000K、4000K), lighting balance,service life over 54000 hours.
- Unleaded welding-free technology detachable structure between wire and light.
- Built-in type installation,cuttable length,Lighting balance.
- PC lampshade,ultra-narrow design and has no crystal points.
- RA>90.

可选灯源色温 COLOR TEMPERATURE ADJUSTABLE

4000K

3000K

安装说明 INSTALLATION INSTRUCTIONS

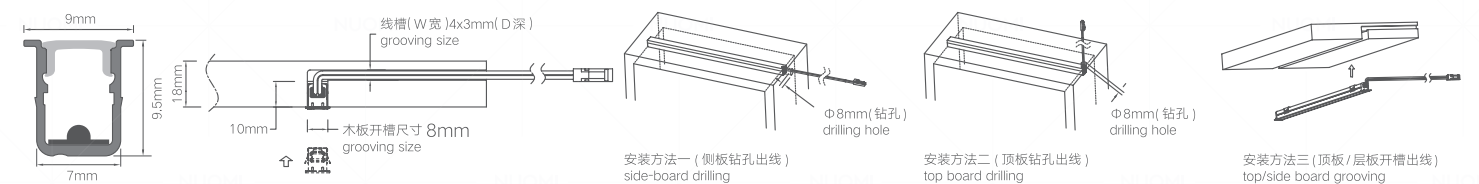

技术参数 TECHNICAL DETAILS

Color Temperature 色温 (K)	Item No. 型号	Item No. 型号	Item No. 型号	Size (mm) 尺寸 (mm)	Cutout Size(WXDmm) 开槽尺寸 (WXDmm)	Power 功率
3000K	Highclass grey 太郎灰	Highclass grey 波尔多红 (定制)	Highclass grey 香槟金 (定制)	500MM	8x10mm	5W
	12813053	12813051	12813052	600MM		6W
	12813063	12813061	12813062	700MM		7W
	12813073	12813071	12813072	800MM		8W
	12813083	12813081	12813082	900MM		9W
	12813093	12813091	12813092	1000MM		10W
	12813103	12813101	12813102	1200MM		12W
	12813123	12813121	12813122	1400MM		14W
	12813143	12813141	12813142	1600MM		16W
	12813163	12813161	12813162	1800MM		18W
	12813183	12813181	12813182	2000MM		20W
	12813203	12813201	12813202	2200MM		22W
	12813223	12813221	12813222	2400MM		24W
	12813243	12813241	12813242	3000MM		30W
	4000K	12814053	12814051	12814052		500MM
12814063		12814061	12814062	600MM	6W	
12814073		12814071	12814072	700MM	7W	
12814083		12814081	12814082	800MM	8W	
12814093		12814091	12814092	900MM	9W	
12814103		12814101	12814102	1000MM	10W	
12814123		12814121	12814122	1200MM	12W	
12814143		12814141	12814142	1400MM	14W	
12814163		12814161	12814162	1600MM	16W	
12814183		12814181	12814182	1800MM	18W	
12814203		12814201	12814202	2000MM	20W	
12814223		12814221	12814222	2200MM	22W	
12814243		12814241	12814242	2400MM	24W	
12814303		12814301	12814302	3000MM	30W	

★ 电压: 12VDC, 连接方式: 诺米免焊端子线 (长度 1.5M, 非标配, 需单独下单)。NUOMI welding-free patch cords (1.5M, additional purchase is required).



产品特点 FEATURES

- 升级密集发光芯片设计, 可调或可选色温 (3000K、4000K) 柔和细腻流光, 无频闪不伤眼;
 - 插入式灯线分离技术, 隐藏式防拉锁定设置, 适用性更广、稳定性更高;
 - 高精度电路板, 全盘满锡工艺, 抗氧化耐高温, 寿命长;
 - 灵活裁剪随心定制, 导电轨道全喷无铅锡工艺, 杜绝氧化;
 - 卡扣式快装快拆结构, 操作更简单, 效率更高。
- Adjustable or optional color temperature(3000K、4000K), lighting balance,service life over 54000 hours.
 - Unleaded welding-free technology detachable structure between wire and light.
 - Built-in type installation, cuttable length, lighting balance.
 - PC lampshade, ultra-narrow design and has no crystal points.
 - RA>90.

可选灯源色温 COLOR TEMPERATURE ADJUSTABLE



安装说明 INSTALLATION INSTRUCTIONS

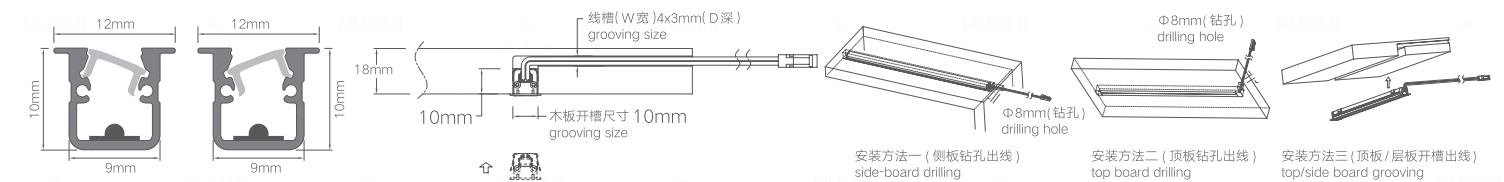

技术参数 TECHNICAL DETAILS

Color Temperature 色温 (K)	Item No. 型号	Highclass grey 太郎灰	Highclass grey 波尔多红 (定制)	Highclass grey 香槟金 (定制)	Size (mm) 尺寸 (mm)	Cutout Size(WXDmm) 开槽尺寸 (WXDmm)	Power 功率	Remark 备注
3000K	12823053	12823051	12823052	500MM	10x10mm		5W	可搭配 1282、1283 堵头 使用
	12823063	12823061	12823062	600MM			6W	
	12823073	12823071	12823072	700MM			7W	
	12823083	12823081	12823082	800MM			8W	
	12823093	12823091	12823092	900MM			9W	
	12823103	12823101	12823102	1000MM			10W	
	12823123	12823121	12823122	1200MM			12W	
	12823143	12823141	12823142	1400MM			14W	
	12823163	12823161	12823162	1600MM			16W	
	12823183	12823181	12823182	1800MM			18W	
	12823203	12823201	12823202	2000MM			20W	
	12823223	12823221	12823222	2200MM			22W	
	12823243	12823241	12823242	2400MM			24W	
	12823303	12823301	12823302	3000MM			30W	
4000K	12824053	12824051	12824052	500MM	10x10mm		5W	可搭配 1282、1283 堵头 使用
	12824063	12824061	12824062	600MM			6W	
	12824073	12824071	12824072	700MM			7W	
	12824083	12824081	12824082	800MM			8W	
	12824093	12824091	12824092	900MM			9W	
	12824103	12824101	12824102	1000MM			10W	
	12824123	12824121	12824122	1200MM			12W	
	12824143	12824141	12824142	1400MM			14W	
	12824163	12824161	12824162	1600MM			16W	
	12824183	12824181	12824182	1800MM			18W	
	12824203	12824201	12824202	2000MM			20W	
	12824223	12824221	12824222	2200MM			22W	
	12824243	12824241	12824242	2400MM			24W	
	12824303	12824301	12824302	3000MM			30W	

★ 电压: 12VDC, 连接方式: 诺米免焊端子线 (长度 1.5M, 非标配, 需单独下单)。NUOMI welding-free patch cords (1.5M, additional purchase is required).



产品特点 FEATURES

- 升级密集发光芯片设计, 可调或可选色温 (3000K、4000K) 柔和细腻流光, 无频闪不伤眼;
 - 插入式灯线分离技术, 隐藏式防拉锁定设置, 适用性更广、稳定性更高;
 - 高精度电路板, 全盘满锡工艺, 抗氧化耐高温, 寿命长;
 - 灵活裁剪随心定制, 导电轨道全喷无铅锡工艺, 杜绝氧化;
 - 卡扣式快装快拆结构, 操作更简单, 效率更高。
- Adjustable or optional color temperature(3000K、4000K), lighting balance,service life over 54000 hours.
 - Unleaded welding-free technology detachable structure between wire and light.
 - Built-in type installation,cutttable length,Lighting balance.
 - PC lampshade,ultra-narrow design and has no crystal points.
 - RA>90.

可选灯源色温 COLOR TEMPERATURE ADJUSTABLE



安装说明 INSTALLATION INSTRUCTIONS

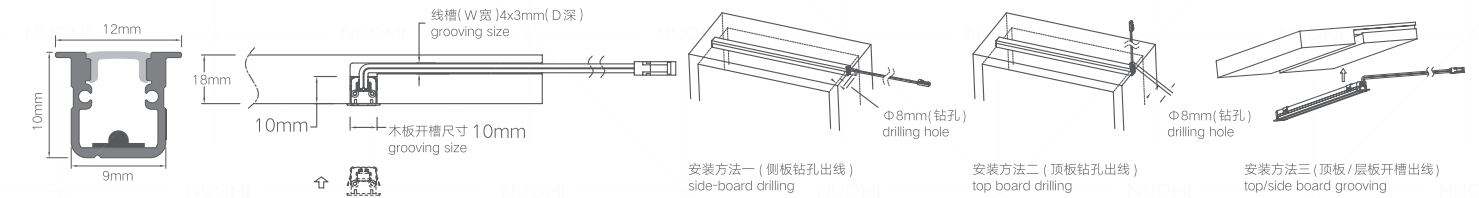

技术参数 TECHNICAL DETAILS

Color Temperature 色温 (K)	Item No. 型号	Highclass grey 太郎灰	Highclass grey 波尔多红 (定制)	Highclass grey 香槟金 (定制)	Size (mm) 尺寸 (mm)	Cutout Size(WXDmm) 开槽尺寸 (WXDmm)	Power 功率	Remark 备注
3000K	12833053	12833051	12833052	500MM	10x10mm		5W	可搭配 1282、1283 堵头 使用
	12833063	12833061	12833062	600MM			6W	
	12833073	12833071	12833072	700MM			7W	
	12833083	12833081	12833082	800MM			8W	
	12833093	12833091	12833092	900MM			9W	
	12833103	12833101	12833102	1000MM			10W	
	12833123	12833121	12833122	1200MM			12W	
	12833143	12833141	12833142	1400MM			14W	
	12833163	12833161	12833162	1600MM			16W	
	12833183	12833181	12833182	1800MM			18W	
	12833203	12833201	12833202	2000MM			20W	
	12833223	12833221	12833222	2200MM			22W	
12833243	12833241	12833242	2400MM	24W				
12833303	12833301	12833302	3000MM	30W				
4000K	12834053	12834051	12834052	500MM	10x10mm		5W	可搭配 1282、1283 堵头 使用
	12834063	12834061	12834062	600MM			6W	
	12834073	12834071	12834072	700MM			7W	
	12834083	12834081	12834082	800MM			8W	
	12834093	12834091	12834092	900MM			9W	
	12834103	12834101	12834102	1000MM			10W	
	12834123	12834121	12834122	1200MM			12W	
	12834143	12834141	12834142	1400MM			14W	
	12834163	12834161	12834162	1600MM			16W	
	12834183	12834181	12834182	1800MM			18W	
	12834203	12834201	12834202	2000MM			20W	
	12834223	12834221	12834222	2200MM			22W	
12834243	12834241	12834242	2400MM	24W				
12834303	12834301	12834302	3000MM	30W				

★ 电压: 12VDC, 连接方式: 诺米免焊端子线 (长度 1.5M, 非标配, 需单独下单)。NUOMI welding-free patch cords (1.5M, additional purchase is required).



产品特点 FEATURES

- 升级密集发光芯片设计, 可调或可选色温 (3000K、4000K) 柔和细腻流光, 无频闪不伤眼;
 - 插入式灯线分离技术, 隐藏式防拉锁定设置, 适用性更广、稳定性更高;
 - 高精度电路板, 全盘满锡工艺, 抗氧化耐高温, 寿命长;
 - 灵活裁剪随心定制, 导电轨道全喷无铅锡工艺, 杜绝氧化;
 - 卡扣式快装快拆结构, 操作更简单, 效率更高。
- Adjustable or optional color temperature(3000K、4000K), lighting balance,service life over 54000 hours.
 - Unleaded welding-free technology detachable structure between wire and light.
 - Built-in type installation,cutttable length,Lighting balance.
 - PC lampshade,ultra-narrow design and has no crystal points.
 - RA>90.

可选灯源色温 COLOR TEMPERATURE ADJUSTABLE



安装说明 INSTALLATION INSTRUCTIONS



技术参数 TECHNICAL DETAILS

Color Temperature 色温 (K)	Item No. 型号	Highclass grey 太郎灰	Highclass grey 波尔多红 (定制)	Highclass grey 香槟金 (定制)	Size (mm) 尺寸 (mm)	Cutout Size(WXDmm) 开槽尺寸 (WXDmm)	Power 功率
3000K	12843053	12843051	12843052	500MM	11x10mm	5W	
	12843063	12843061	12843062	600MM		6W	
	12843073	12843071	12843072	700MM		7W	
	12843083	12843081	12843082	800MM		8W	
	12843093	12843091	12843092	900MM		9W	
	12843103	12843101	12843102	1000MM		10W	
	12843123	12843121	12843122	1200MM		12W	
	12843143	12843141	12843142	1400MM		14W	
	12843163	12843161	12843162	1600MM		16W	
	12843183	12843181	12843182	1800MM		18W	
	12843203	12843201	12843202	2000MM		20W	
	12843223	12843221	12843222	2200MM		22W	
	12843243	12843241	12843242	2400MM		24W	
	12843303	12843301	12843302	3000MM		30W	
4000K	12844053	12844051	12844052	500MM	11x10mm	5W	
	12844063	12844061	12844062	600MM		6W	
	12844073	12844071	12844072	700MM		7W	
	12844083	12844081	12844082	800MM		8W	
	12844093	12844091	12844092	900MM		9W	
	12844103	12844101	12844102	1000MM		10W	
	12844123	12844121	12844122	1200MM		12W	
	12844143	12844141	12844142	1400MM		14W	
	12844163	12844161	12844162	1600MM		16W	
	12844183	12844181	12844182	1800MM		18W	
	12844203	12844201	12844202	2000MM		20W	
	12844223	12844221	12844222	2200MM		22W	
	12844243	12844241	12844242	2400MM		24W	
	12844303	12844301	12844302	3000MM		30W	

★ 电压: 12VDC, 连接方式: 诺米免焊端子线 (长度 1.5M, 非标配, 需单独下单)。NUOMI welding-free patch cords (1.5M, additional purchase is required).



产品特点 FEATURES

- 升级密集发光芯片设计，可调或可选色温（3000K、4000K）柔和细腻流光，无频闪不伤眼；
 - 插入式灯线分离技术，隐藏式防拉锁定设置，适用性更广、稳定性更高；
 - 高精度电路板，全盘满锡工艺，抗氧化耐高温，寿命长；
 - 灵活裁剪随心定制，导电轨道全喷无铅锡工艺，杜绝氧化；
 - 卡扣式快装快拆结构，操作更简单，效率更高。
- Adjustable or optional color temperature(3000K、4000K), lighting balance,service life over 54000 hours.
 - Unleaded welding-free technology detachable structure between wire and light.
 - Built-in type installation,cutttable length,Lighting balance.
 - PC lampshade,ultra-narrow design and has no crystal points.
 - RA>90.

可选灯源色温 COLOR TEMPERATURE ADJUSTABLE



安装说明 INSTALLATION INSTRUCTIONS

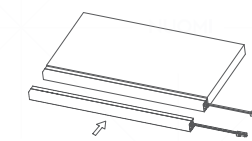
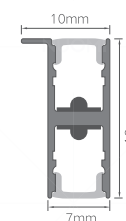

灯具安装在层板边的安装板上

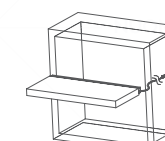

层板（含灯具）安装在柜子里

层板错位 7mm, 背板钻孔出线
depth of layered board shorter 7mm

技术参数 TECHNICAL DETAILS

Color Temperature 色温 (K)	Item No. 型号	Highclass grey 太郎灰	Highclass grey 波尔多红 (定制)	Highclass grey 香槟金 (定制)	Size (mm) 尺寸 (mm)	Power 功率	Remark 备注
3000K	12853053	12853051	12853052	500MM	10W		
	12853063	12853061	12853062	600MM	12W		
	12853073	12853071	12853072	700MM	14W		
	12853083	12853081	12853082	800MM	16W		
	12853093	12853091	12853092	900MM	18W		
	12853103	12853101	12853102	1000MM	20W		使用二合一 免焊端子线
	12853123	12853121	12853122	1200MM	24W		
	12853143	12853141	12853142	1400MM	28W		
	12853163	12853161	12853162	1600MM	32W		
	12853183	12853181	12853182	1800MM	36W		
	12853203	12853201	12853202	2000MM	40W		
	12853223	12853221	12853222	2200MM	44W		使用两条 免焊端子线
	12853243	12853241	12853242	2400MM	48W		
	12853303	12853301	12853302	3000MM	60W		
4000K	12854053	12854051	12854052	500MM	10W		
	12854063	12854061	12854062	600MM	12W		
	12854073	12854071	12854072	700MM	14W		
	12854083	12854081	12854082	800MM	16W		
	12854093	12854091	12854092	900MM	18W		
	12854103	12854101	12854102	1000MM	20W		使用二合一 免焊端子线
	12854123	12854121	12854122	1200MM	24W		
	12854143	12854141	12854142	1400MM	28W		
	12854163	12854161	12854162	1600MM	32W		
	12854183	12854181	12854182	1800MM	36W		
	12854203	12854201	12854202	2000MM	40W		
	12854223	12854221	12854222	2200MM	44W		使用两条 免焊端子线
12854243	12854241	12854242	2400MM	48W			
12854303	12854301	12854302	3000MM	60W			

★ 电压：12VDC，连接方式：诺米免焊端子线或二合一免焊端子线（长度 1.5M，非标配，需单独下单）。NUOMI welding-free or two-in-one welding-free patch cords (1.5M, additional purchase is required).



产品特点 FEATURES

- 升级密集发光芯片设计, 可调或可选色温 (3000K、4000K) 柔和细腻流光, 无频闪不伤眼;
- 插入式灯线分离技术, 隐藏式防拉锁定设置, 适用性更广、稳定性更高;
- 高精度电路板, 全盘满锡工艺, 抗氧化耐高温, 寿命长;
- 灵活裁剪随心定制, 导电轨道全喷无铅锡工艺, 杜绝氧化;
- 卡扣式快装快拆结构, 操作更简单, 效率更高。

- Adjustable or optional color temperature(3000K、4000K), lighting balance,service life over 54000 hours.
- Unleaded welding-free technology detachable structure between wire and light.
- Built-in type installation,cutttable length,Lighting balance.
- PC lampshade,ultra-narrow design and has no crystal points.
- RA>90.

可选灯源色温 COLOR TEMPERATURE ADJUSTABLE



安装说明 INSTALLATION INSTRUCTIONS

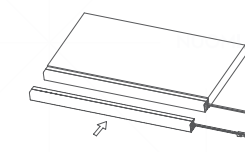
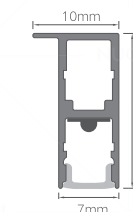

灯具安装在层板边的安装板上

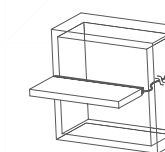

层板(含灯具)安装在柜子里

层板错位 7mm, 背板钻孔出线
depth of layered board shorter 7mm

技术参数 TECHNICAL DETAILS

Color Temperature 色温 (K)	Item No. 型号	Highclass grey 太郎灰	Highclass grey 波尔多红 (定制)	Highclass grey 香槟金 (定制)	Size (mm) 尺寸 (mm)	Power 功率
3000K	12863053	12863051	12863052	500MM	5W	
	12863063	12863061	12863062	600MM	6W	
	12863073	12863071	12863072	700MM	7W	
	12863083	12863081	12863082	800MM	8W	
	12863093	12863091	12863092	900MM	9W	
	12863103	12863101	12863102	1000MM	10W	
	12863123	12863121	12863122	1200MM	12W	
	12863143	12863141	12863142	1400MM	14W	
	12863163	12863161	12863162	1600MM	16W	
	12863183	12863181	12863182	1800MM	18W	
	12863203	12863201	12863202	2000MM	20W	
	12863223	12863221	12863222	2200MM	22W	
	12863243	12863241	12863242	2400MM	24W	
	12863303	12863301	12863302	3000MM	30W	
4000K	12864053	12864051	12864052	500MM	5W	
	12864063	12864061	12864062	600MM	6W	
	12864073	12864071	12864072	700MM	7W	
	12864083	12864081	12864082	800MM	8W	
	12864093	12864091	12864092	900MM	9W	
	12864103	12864101	12864102	1000MM	10W	
	12864123	12864121	12864122	1200MM	12W	
	12864143	12864141	12864142	1400MM	14W	
	12864163	12864161	12864162	1600MM	16W	
	12864183	12864181	12864182	1800MM	18W	
	12864203	12864201	12864202	2000MM	20W	
	12864223	12864221	12864222	2200MM	22W	
	12864243	12864241	12864242	2400MM	24W	
	12864303	12864301	12864302	3000MM	30W	

★ 电压: 12VDC, 连接方式: 诺米免焊端子线 (长度 1.5M, 非标配, 需单独下单)。NUOMI welding-free patch cords (1.5M, additional purchase is required).



产品特点 FEATURES

- 升级密集发光芯片设计, 可调或可选色温 (3000K、4000K) 柔和细腻流光, 无频闪不伤眼;
 - 插入式灯线分离技术, 隐藏式防拉锁定设置, 适用性更广、稳定性更高;
 - 高精度电路板, 全盘满锡工艺, 抗氧化耐高温, 寿命长;
 - 灵活裁剪随心定制, 导电轨道全喷无铅锡工艺, 杜绝氧化;
 - 卡扣式快装快拆结构, 操作更简单, 效率更高。
- Adjustable or optional color temperature(3000K、4000K), lighting balance,service life over 54000 hours.
 - Unleaded welding-free technology detachable structure between wire and light.
 - Built-in type installation,cutttable length,Lighting balance.
 - PC lampshade,ultra-narrow design and has no crystal points.
 - RA>90.

可选灯源色温 COLOR TEMPERATURE ADJUSTABLE



安装说明 INSTALLATION INSTRUCTIONS

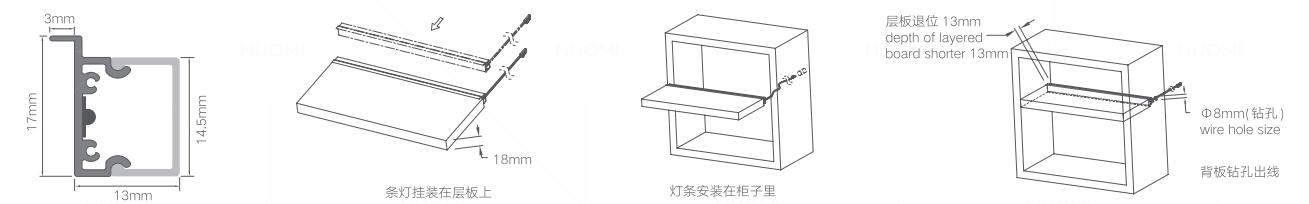

技术参数 TECHNICAL DETAILS

Color Temperature 色温 (K)	Item No. 型号	Item No. 型号	Item No. 型号	Size (mm) 尺寸 (mm)	Power 功率
3000K	Highclass grey 太郎灰	Highclass grey 波尔多红 (定制)	Highclass grey 香槟金 (定制)		
	12873053	12873051	12873052	500MM	5W
	12873063	12873061	12873062	600MM	6W
	12873073	12873071	12873072	700MM	7W
	12873083	12873081	12873082	800MM	8W
	12873093	12873091	12873092	900MM	9W
	12873103	12873101	12873102	1000MM	10W
	12873123	12873121	12873122	1200MM	12W
	12873143	12873141	12873142	1400MM	14W
	12873163	12873161	12873162	1600MM	16W
	12873183	12873181	12873182	1800MM	18W
	12873203	12873201	12873202	2000MM	20W
	12873223	12873221	12873222	2200MM	22W
	12873243	12873241	12873242	2400MM	24W
	12873303	12873301	12873302	3000MM	30W
4000K	12874053	12874051	12874052	500MM	5W
	12874063	12874061	12874062	600MM	6W
	12874073	12874071	12874072	700MM	7W
	12874083	12874081	12874082	800MM	8W
	12874093	12874091	12874092	900MM	9W
	12874103	12874101	12874102	1000MM	10W
	12874123	12874121	12874122	1200MM	12W
	12874143	12874141	12874142	1400MM	14W
	12874163	12874161	12874162	1600MM	16W
	12874183	12874181	12874182	1800MM	18W
	12874203	12874201	12874202	2000MM	20W
	12874223	12874221	12874222	2200MM	22W
	12874243	12874241	12874242	2400MM	24W
	12874303	12874301	12874302	3000MM	30W

★ 电压: 12VDC, 连接方式: 诺米免焊端子线 (长度 1.5M, 非标配, 需单独下单)。NUOMI welding-free patch cords (1.5M, additional purchase is required).



产品特点 FEATURES

- 升级密集发光芯片设计, 可调或可选色温 (3000K、4000K) 柔和细腻流光, 无频闪不伤眼;
 - 插入式灯线分离技术, 隐藏式防拉锁定设置, 适用性更广、稳定性更高;
 - 高精度电路板, 全盘满锡工艺, 抗氧化耐高温, 寿命长;
 - 灵活裁剪随心定制, 导电轨道全喷无铅锡工艺, 杜绝氧化;
 - 卡扣式快装快拆结构, 操作更简单, 效率更高。
- Adjustable or optional color temperature(3000K、4000K), lighting balance,service life over 54000 hours.
 - Unleaded welding-free technology detachable structure between wire and light.
 - Built-in type installation,cutttable length,Lighting balance.
 - PC lampshade,ultra-narrow design and has no crystal points.
 - RA>90.

可选灯源色温 COLOR TEMPERATURE ADJUSTABLE



安装说明 INSTALLATION INSTRUCTIONS

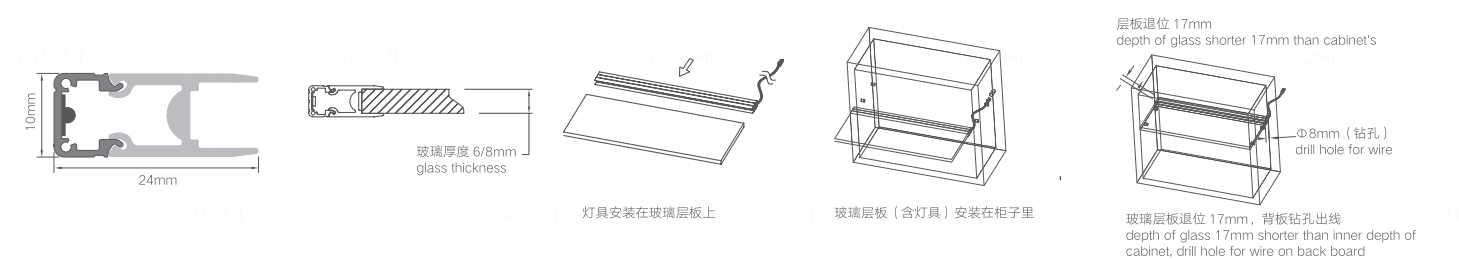

技术参数 TECHNICAL DETAILS

Color Temperature 色温 (K)	Item No. 型号	Highclass grey 太郎灰	Highclass grey 波尔多红 (定制)	Highclass grey 香槟金 (定制)	Size (mm) 尺寸 (mm)	Power 功率
3000K	12883053	12883051	12883052	500MM	5W	
	12883063	12883061	12883062	600MM	6W	
	12883073	12883071	12883072	700MM	7W	
	12883083	12883081	12883082	800MM	8W	
	12883093	12883091	12883092	900MM	9W	
	12883103	12883101	12883102	1000MM	10W	
	12883123	12883121	12883122	1200MM	12W	
	12883143	12883141	12883142	1400MM	14W	
	12883163	12883161	12883162	1600MM	16W	
	12883183	12883181	12883182	1800MM	18W	
	12883203	12883201	12883202	2000MM	20W	
	12883223	12883221	12883222	2200MM	22W	
	12883243	12883241	12883242	2400MM	24W	
	12883303	12883301	12883302	3000MM	30W	
4000K	12884053	12884051	12884052	500MM	5W	
	12884063	12884061	12884062	600MM	6W	
	12884073	12884071	12884072	700MM	7W	
	12884083	12884081	12884082	800MM	8W	
	12884093	12884091	12884092	900MM	9W	
	12884103	12884101	12884102	1000MM	10W	
	12884123	12884121	12884122	1200MM	12W	
	12884143	12884141	12884142	1400MM	14W	
	12884163	12884161	12884162	1600MM	16W	
	12884183	12884181	12884182	1800MM	18W	
	12884203	12884201	12884202	2000MM	20W	
	12884223	12884221	12884222	2200MM	22W	
	12884243	12884241	12884242	2400MM	24W	
	12884303	12884301	12884302	3000MM	30W	

★ 电压: 12VDC, 连接方式: 诺米免焊端子线 (长度 1.5M, 非标配, 需单独下单)。NUOMI welding-free patch cords (1.5M, additional purchase is required).



产品特点 FEATURES

- 升级密集发光芯片设计，可调或可选色温（3000K、4000K）柔和细腻流光，无频闪不伤眼；
- 插入式灯线分离技术，隐藏式防拉锁定设置，适用性更广、稳定性更高；
- 高精度电路板，全盘满锡工艺，抗氧化耐高温，寿命长；
- 灵活裁剪随心定制，导电轨道全喷无铅锡工艺，杜绝氧化；
- 卡扣式快装快拆结构，操作更简单，效率更高。

- Adjustable or optional color temperature(3000K、4000K), lighting balance,service life over 54000 hours.
- Unleaded welding-free technology detachable structure between wire and light.
- Built-in type installation,cutttable length,Lighting balance.
- PC lampshade,ultra-narrow design and has no crystal points.
- RA>90.

可选灯源色温 COLOR TEMPERATURE ADJUSTABLE

4000K

3000K

安装说明 INSTALLATION INSTRUCTIONS

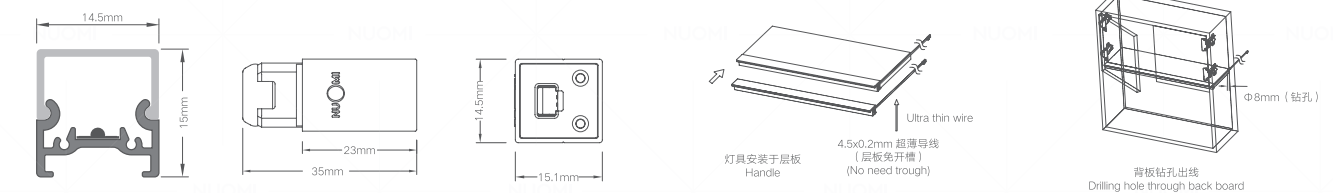

技术参数 TECHNICAL DETAILS

Color Temperature 色温 (K)	Item No. 型号	Champagne golden 香槟金	Highclass grey 太郎灰	Bordeaux red 波尔多红	Size (mm) 尺寸 (mm)	Power 功率	Sensor switch 感应开关
3000K	12893302	12893303	12893301	3000mm	10W/M		
4000K	12894302	12894303	12894301	3000mm	10W/M		带手扫感应开关 hand sweep sensor switch
免焊门控感应堵头	12222019	12222017	12222018	/	/		
左堵头	12890002A	12890003A	12890001A	/	/		不带感应开关 without sensor switch
免焊右堵头	12890002B	12890003B	12890001B	/	/		

★ 电压：12VDC，连接方式：杜邦端子线（1.5M）。Dupont wire（1.5M）。



产品特点 FEATURES

- 采用高品质 LED 光源，可选色温（3000K、4000K），可调亮度，出光均匀，70000 小时超长寿命；
- 免开槽免拉手设计，下发光，自带手扫感应，适用于橱柜吊柜安装；
- 标配超薄导线，走线不再钻孔外露；
- 显指 Ra>90。
- Optional color temperature, adjustable brilliance, lighting balance, service life over 70000 hours.
- No need trough, lighting downward, hand sweep sensor, suitable for wall cupboard, used in wardrobe strong load-bearing.
- Ultra thin wire, no need hole drilling.
- Ra>90.

可选灯源色温 COLOR TEMPERATURE ADJUSTABLE



安装说明 INSTALLATION INSTRUCTIONS

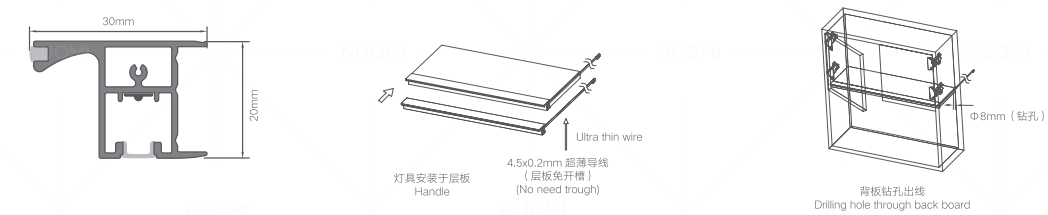

技术参数 TECHNICAL DETAILS

Color Temperature 色温 (K)	Item No. 型号	Champagne golden 香槟金	Highclass grey 太郎灰	Bordeaux red 波尔多红	Size (mm) 尺寸 (mm)	Power 功率	Sensor switch 感应开关
3000K	12913302	12914303	12913301	3000mm	10W/M	带手扫感应开关 hand sweep sensor switch	
4000K	12914302	12914303	12914301	3000mm	10W/M		
手扫感应堵头	12222028	12222026	12222027	/	/		

★ 电压：12VDC，连接方式：杜邦端子线（1.5M）。Dupont wire（1.5M）。





产品特点 FEATURES

- 采用高品质 LED 光源，可选色温（3000K、4000K），可调亮度，出光均匀，70000 小时超长寿命；
- 用于衣柜中，结实铝材，承重力强；
- 铝型材水性氟碳喷涂工艺；
- 显指 Ra>90。
- Optional color temperature, adjustable brilliance, lighting balance, service life over 70000 hours.
- Used in wardrobe, strong load-bearing.
- Aluminium profile, waterborne fluorocarbon coating technology.
- Ra>90.

可选灯源色温 COLOR TEMPERATURE ADJUSTABLE



安装说明 INSTALLATION INSTRUCTIONS

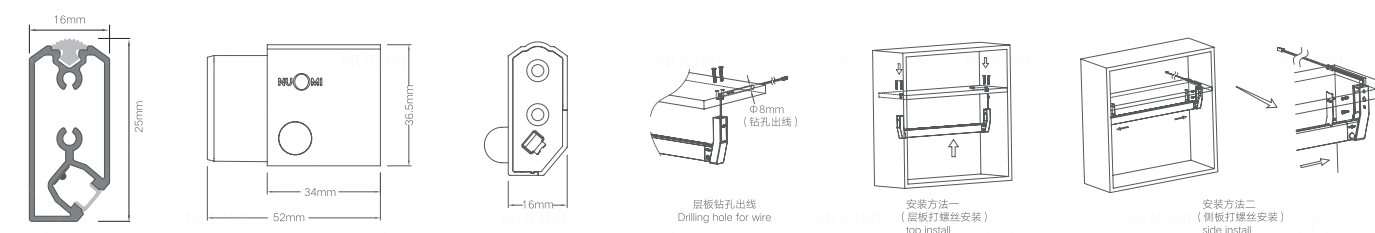

技术参数 TECHNICAL DETAILS

Color Temperature 色温 (K)	Item No. 型号	Bordeaux red 波尔多红	Champagne golden 香槟金	Highclass grey 太郎灰	Size (mm) 尺寸 (mm)	Power 功率	Sensor switch 感应开关
3000K	12803301		12803302	12803303	3000mm	10W/M	
4000K	12804301		12804302	12804303	3000mm	10W/M	人体红外感应开关 Body infrared sensor switch
免焊人体感应堵头	12804301		12804302	12804303	/	/	

★ 电压：12VDC，连接方式：杜邦端子线（1.5M）。Dupont wire（1.5M）。

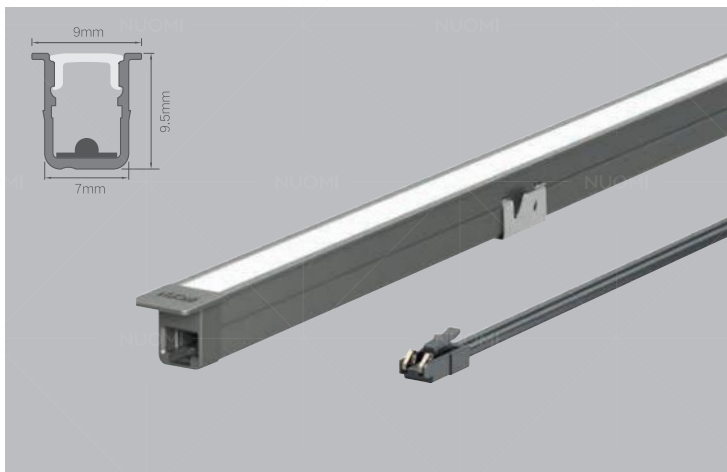

内嵌式超窄灯条 -DIY 配件

Color Temperature 色温 (K)	Item No. 型号	Highclass grey 太郎灰	Bordeaux red 波尔多红 (定制)	Champagne golden 香槟金 (定制)	Size (mm) 尺寸 (mm)	备注
3000K 铝型材 + 灯罩	12813003	12813001	12813002	3000MM	/	
4000K 铝型材 + 灯罩	12814003	12814001	12814002	3000MM	/	
堵头	12810003A	12810001A	12810002A	PC 材质	/	
免焊堵头	12810003B	12810001B	12810002B	PC 材质	/	



嵌入式斜射灯条 -DIY 配件

Color Temperature 色温 (K)	Item No. 型号	Highclass grey 太郎灰	Bordeaux red 波尔多红 (定制)	Champagne golden 香槟金 (定制)	Size (mm) 尺寸 (mm)	备注
3000K 铝型材 + 灯罩	12823003	12823001	12823002	3000MM	/	
4000K 铝型材 + 灯罩	12824003	12824001	12824002	3000MM	/	
堵头	12820003A	12820001A	12820002A	PC 材质	与 1283 共用	
免焊堵头	12820003B	12820001B	12820002B	PC 材质	与 1283 共用	



嵌入式灯条 (铝材翻边) -DIY 配件

Color Temperature 色温 (K)	Item No. 型号	Highclass grey 太郎灰	Bordeaux red 波尔多红 (定制)	Champagne golden 香槟金 (定制)	Size (mm) 尺寸 (mm)	备注
3000K 铝型材 + 灯罩	12833003	12833001	12833002	3000MM	/	
4000K 铝型材 + 灯罩	12834003	12834001	12834002	3000MM	/	
堵头	12820003A	12820001A	12820002A	PC 材质	与 1282 共用	
免焊堵头	12820003B	12820001B	12820002B	PC 材质	与 1282 共用	

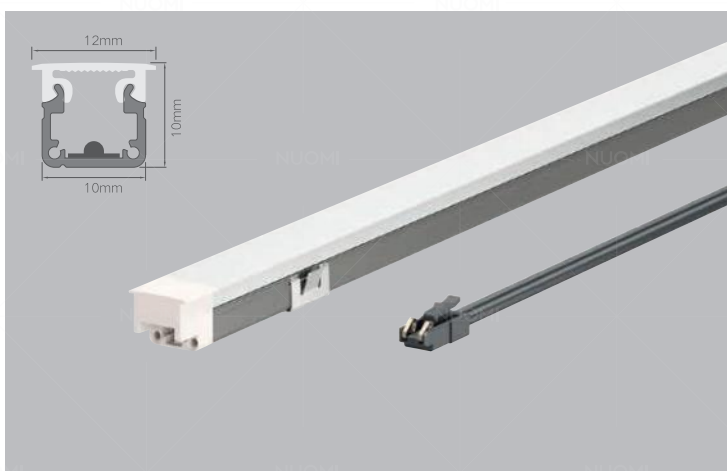

嵌入式灯条 (灯罩翻边) -DIY 配件

Color Temperature 色温 (K)	Item No. 型号	Highclass grey 太郎灰	Bordeaux red 波尔多红 (定制)	Champagne golden 香槟金 (定制)	Size (mm) 尺寸 (mm)	备注
3000K 铝型材 + 灯罩	12843003	12843001	12843002	3000MM	/	
4000K 铝型材 + 灯罩	12844003	12844001	12844002	3000MM	/	
免焊堵头	12843001A	12843001A	12843001A	乳白色	/	



明装后口上下发光灯条 -DIY 配件

Color Temperature 色温 (K)	Item No. 型号	Highclass grey 太郎灰	Bordeaux red 波尔多红 (定制)	Champagne golden 香槟金 (定制)	Size (mm) 尺寸 (mm)	备注
3000K 铝型材 + 灯罩	12853003	12853001	12853002	3000MM	/	
4000K 铝型材 + 灯罩	12854003	12854001	12854002	3000MM	/	
左堵头	12850003A	12850001A	12850002A	PC 材质	与 1286 共用	
免焊右堵头	12850003B	12850001B	12850002B	PC 材质	与 1286 共用	

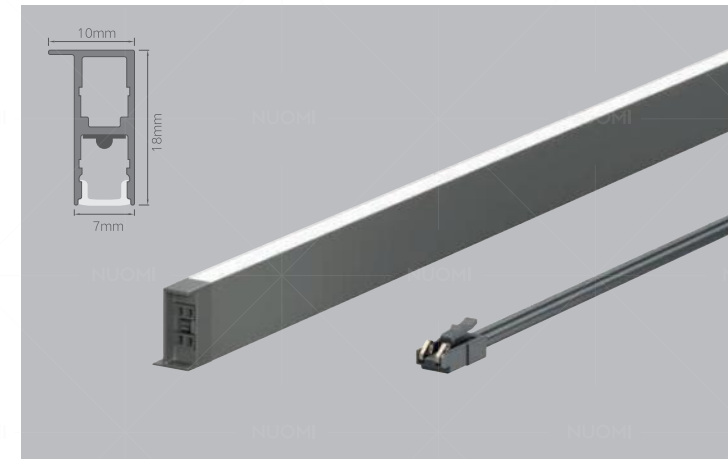

明装后口下发光灯条 -DIY 配件

Color Temperature 色温 (K)	Item No. 型号	Highclass grey 太郎灰	Bordeaux red 波尔多红 (定制)	Champagne golden 香槟金 (定制)	Size (mm) 尺寸 (mm)	备注
3000K 铝型材 + 灯罩	12863003	12863001	12863002	3000MM	/	
4000K 铝型材 + 灯罩	12864003	12864001	12864002	3000MM	/	
左堵头	12850003A	12850001A	12850002A	PC 材质	与 1285 共用	
免焊右堵头	12850003B	12850001B	12850002B	PC 材质	与 1285 共用	

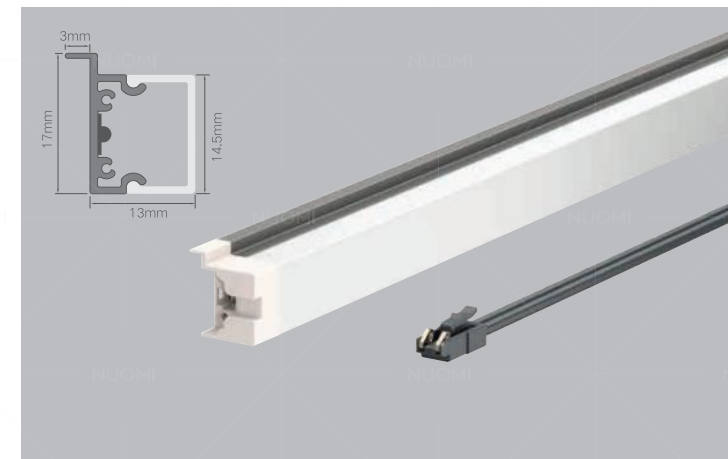

免安装后口层板灯 -DIY 配件

Color Temperature 色温 (K)	Item No. 型号	Highclass grey 太郎灰	Bordeaux red 波尔多红 (定制)	Champagne golden 香槟金 (定制)	Size (mm) 尺寸 (mm)	备注
3000K 铝型材 + 灯罩	12873003	12873001	12873002	3000MM	/	
4000K 铝型材 + 灯罩	12874003	12874001	12874002	3000MM	/	
左堵头	12873001B	12873001B	12873001B	乳白色	/	
免焊右堵头	12873001A	12873001A	12873001A	乳白色	/	



玻璃层板灯条 -DIY 配件

Color Temperature 色温 (K)	Item No. 型号	Highclass grey 太郎灰	Bordeaux red 波尔多红 (定制)	Champagne golden 香槟金 (定制)	Size (mm) 尺寸 (mm)	备注
3000K 铝型材 + 灯罩	12883003	12883001	12883002	3000MM	/	
4000K 铝型材 + 灯罩	12884003	12884001	12884002	3000MM	/	
免焊堵头	12883001A	12883001A	12883001A	乳白色	/	

CONCISE AND NEAT

ROCKS LIGHT

洛克斯系列

The line and surface run through as a whole, conveying a more restrained and calm atmosphere. Inverted and elegant are written into the space, with its own gentle lighting, making the visual presentation more concise and neat.

线面贯穿为一体，传递一种更为克制、沉稳的氛围。

将内敛与优雅写入空间，自带温雅的光，让视觉呈现更为简净、利落。

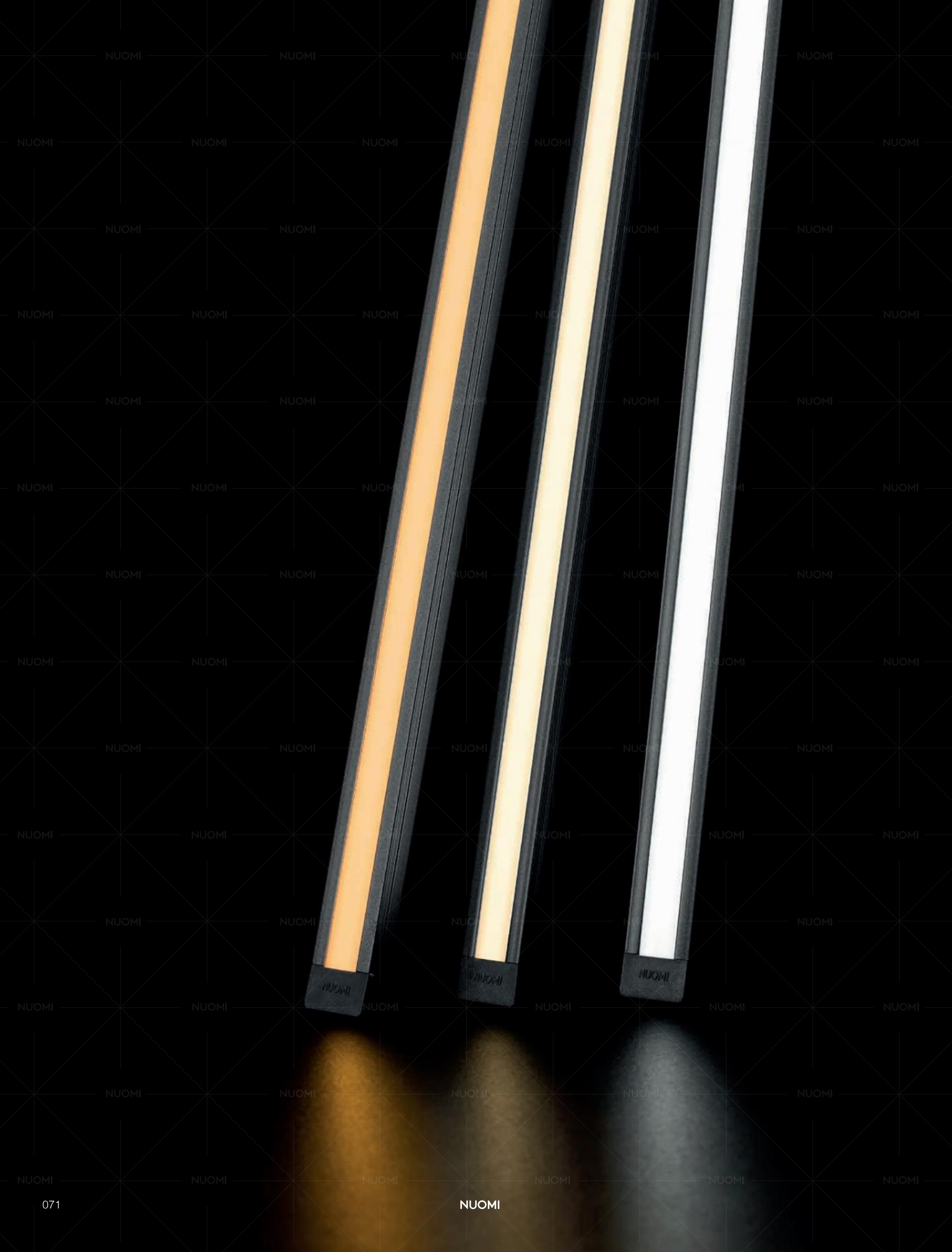

ROCKS LIGHT

洛克斯系列



Clean and comfortable space, more full and orderly combination of different modules, breaking the monotony of the plane, bring undulating rhythm.

干净而舒适的空间，不同模块组合更显饱满有序，突破了平面的单调，带来更具起伏的韵律与节奏。

真正的灯线分离

- 镀金触点与全锡焊盘精准对接
- 防拉锁定设置，插头不松脱

高配灯带 发光效果更好



0.8cm



高配灯带理论最大发光暗区 0.8cm

全锡焊盘，杜绝触点氧化

- 无铅全锡焊盘，抗氧化、且环保
- 超强抗氧化，通过 48 小时盐雾测试

48

 hours

全锡焊盘

镀金触点

锁定弹片

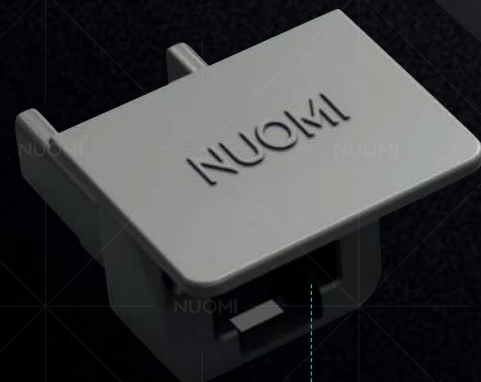

孔位

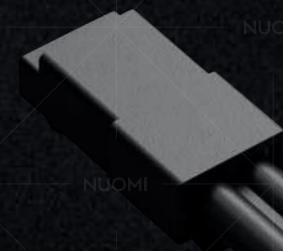

SIX CORE SELLING POINTS 六大核心卖点



1、极简超窄
MINIMALISM ULTRA NARROW
STRIP LIGHTS

- 迎合当下流行的极简轻奢风格需要的极简超窄灯条款式；
- 极简超窄 PC 灯条，发光面低至 5.8mm，行业极窄。

- Follow current trend, minimalism light luxury style
- Ultra narrow pc lampshade, luminous surface area 5.8mm.

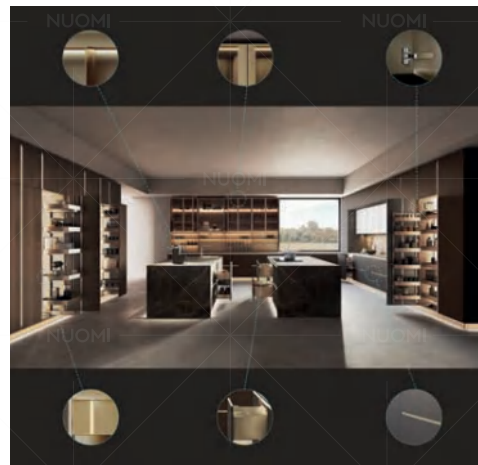

2、全屋五金轻奢同色
WHOLE HOUSE HARDWARE
KEEP COLOR CONSISTENCY IN
LIGHT LUXURY STYLE

- 诺米打造的全屋五金产品生态链，基于完善的产品体系，实现全屋五金轻奢同色。
- 全屋所有的五金，包括拉篮、衣帽间收纳、拉手、灯光等，家居里能见光的五金颜色一致，整体性更强，突显高级感。

- Based on complete product system and own surface treatment factory, nuomi keep whole house hardware in consistency light luxury color.
- Including kitchen storage system, wardrobe storage system, handles etc., Whole house hardware keep color consistency, makes overall design more integrated, advanced design sense stands out.

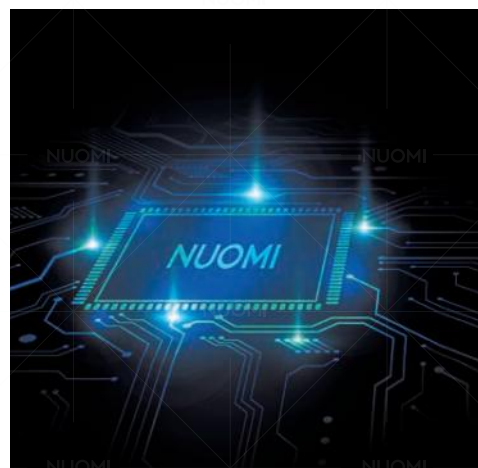

3、顶流智能控制系统
INDUSTRY-LEADING SMART CONTROL
SYSTEM

- 全面覆盖多语音平台、手扫、人身红外感应、门板感应等控制方式；
- 聚集国内外行业精英工程师的强大研发团队，沉淀多年技术积累，自主创新专利技术。

- Smart control system including various ways, multivoice platform, hand-sweeping induction, human body infrared induction, gate induction, etc.
- Gathering industry senior elites, with many years technology and experience, nuomi have strong r&d ability, own many creative patent.

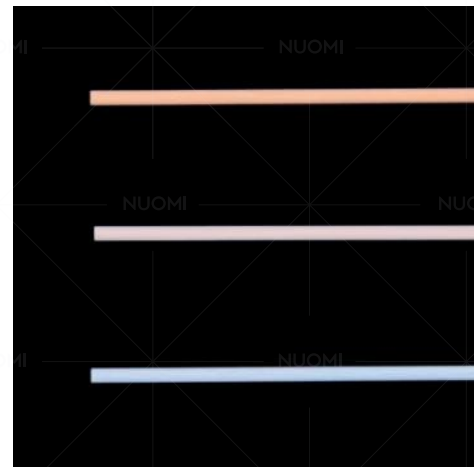

4、3 色温智能切换技术
SMART SWITCH TECHNOLOGY OF THREE
COLORS TEMPERATURE

- 磁悬式 AI 智能 3 色温切换技术；
- 满足用户不同场景的色温需求，灵活控制轻松切换；家居生活体验更丰富，应用更贴心。

- Industry-leading smart switch of three colors temperature.
- Fulfill different application of scenarios, flexible and convenient. Provide rich home living experience, intimate design.



5、高标准产品质量保障
HIGH STANDARD PRODUCT QUALITY
GUARANTEE

- 超欧标的电源电子元件、电路板；
- 光源灯珠采用国际品牌高亮芯片，高强度支架封装，灯珠显指 90 以上；
- 电源和灯珠，在正常使用情况下提供 10 年质保。

- Quality of electric components, circuit board use the highest standard of industry.
- High brightness led of sanan, strong rack, ra of led ≥ 90
- 10 Years service life for power supply and led



6、灯线分离及卡扣式的快装结构
LIGHT AND WIRE SEPARATION STRUCTURE,
CLIP-ON TYPE FAST MOUNTED

- 采用插入式灯线分离技术，检修无忧；
- 卡扣式快装快拆结构，解决安装痛点；
- 防拉锁定装置，插线不松脱。

- Inserted light-wire separation structure, meanwhile guarantee quality;
- Clip-on fast mounted structure, solve installation difficulty;
- Anti-pull locking device, the plug will not be loosened.



产品特点 FEATURES

- 采用高品质 LED 光源, 可调或可选色温 (3000K、4000K、6000K) 可调亮度, 出光均匀, 54000 小时超长寿命;
- 采用无铅免焊技术, 灯线分离结构;
- 可用于嵌入式层板、立板安装, 灯条可裁切;
- 超窄设计 PC 灯罩, 无晶点;
- 显指 >90。
- Adjustable or optional color temperature(3000K、4000K、6000K), lighting balance,service life over 54000 hours.
- Unleaded welding-free technology detachable structure between wire and light.
- Built-in type installation,cutttable length,lighting balance.
- PC lampshade,ultra-narrow design and has no crystal points.
- RA>90.

可调灯源色温 COLOR TEMPERATURE ADJUSTABLE



安装说明 INSTALLATION INSTRUCTIONS

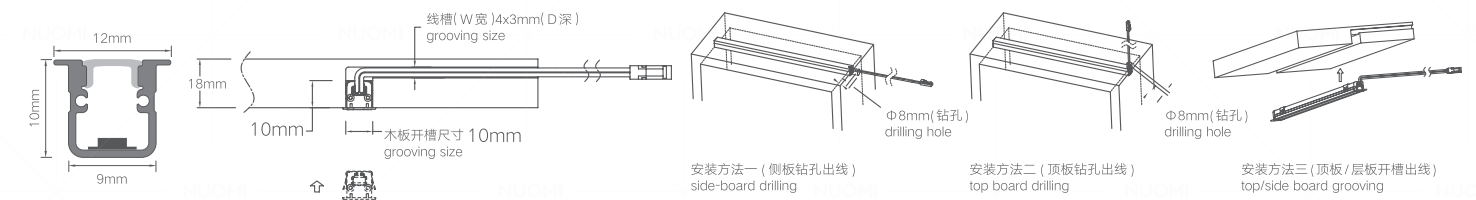

技术参数 TECHNICAL DETAILS

Color Temperature 色温 (K)	Item No. 型号	Highclass grey 太郎灰	Highclass grey 波尔多红 (定制)	Highclass grey 香槟金 (定制)	Size (mm) 尺寸 (mm)	Cutout Size (WXDmm) 开槽尺寸 (WXDmm)	Power 功率
可调 3 色温 (3000K- 4000K- 6000K) 通过智能 控制盒 实现 3 色温 自由调节	12780053		12780051	12780052	500MM	10x10mm	5W
	12780063		12780061	12780062	600MM		6W
	12780073		12780071	12780072	700MM		7W
	12780083		12780081	12780082	800MM		8W
	12780093		12780091	12780092	900MM		9W
	12780103		12780101	12780102	1000MM		10W
	12780123		12780121	12780122	1200MM		12W
	12780143		12780141	12780142	1400MM		14W
	12780163		12780161	12780162	1600MM		16W
	12780183		12780181	12780182	1800MM		18W
	12780203		12780201	12780202	2000MM		20W
	12780223		12780221	12780222	2200MM		22W
	12780243		12780241	12780242	2400MM		24W
	12780303		12780301	12780302	3000MM		30W

* 电压: 12VDC, 连接方式: 诺米免焊端子线 (长度 1.5M, 非标配, 需单独下单)。NUOMI welding-free patch cords (1.5M, additional purchase is required).



产品特点 FEATURES

- 采用高品质 LED 光源，可调或可选色温（3000K、4000K、6000K）可调亮度，出光均匀，54000 小时超长寿命；
- 采用无铅免焊技术，灯线分离结构；
- 见光不见灯，灯条可裁切；
- 超窄设计 PC 灯罩，无晶点；
- 显指 >90。
- Adjustable or optional color temperature(3000K、4000K、6000K), lighting balance, service life over 54000 hours.
- Unleaded welding-free technology detachable structure between wire and light.
- Cuttable length.
- PC lampshade, ultra-narrow design and has no crystal points.
- RA>90.

可调灯源色温 COLOR TEMPERATURE ADJUSTABLE

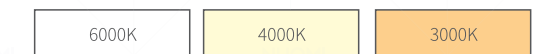

安装说明 INSTALLATION INSTRUCTIONS

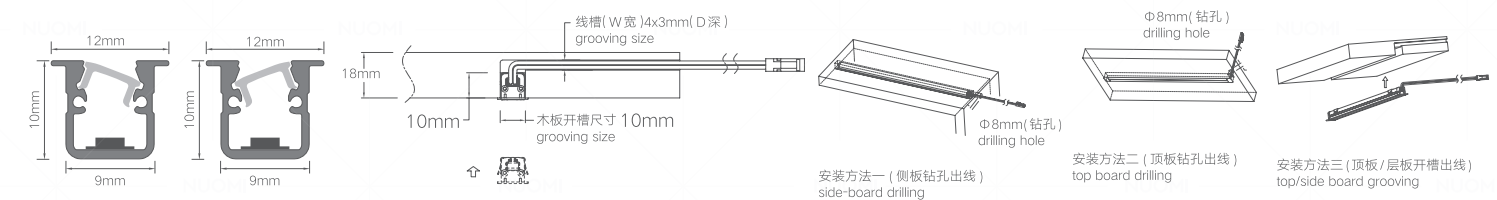

技术参数 TECHNICAL DETAILS

Color Temperature 色温 (K)	Item No. 型号	Highclass grey 太郎灰	Highclass grey 波尔多红 (定制)	Highclass grey 香槟金 (定制)	Size (mm) 尺寸 (mm)	Cutout Size (WXDmm) 开槽尺寸 (WXDmm)	Power 功率
可调 3 色温 (3000K- 4000K- 6000K) 通过智能 控制盒 实现 3 色温 自由调节	12720053		12720051	12720052	500MM	10x10mm	5W
	12720063		12720061	12720062	600MM		6W
	12720073		12720071	12720072	700MM		7W
	12720083		12720081	12720082	800MM		8W
	12720093		12720091	12720092	900MM		9W
	12720103		12720101	12720102	1000MM		10W
	12720123		12720121	12720122	1200MM		12W
	12720143		12720141	12720142	1400MM		14W
	12720163		12720161	12720162	1600MM		16W
	12720183		12720181	12720182	1800MM		18W
	12720203		12720201	12720202	2000MM		20W
	12720223		12720221	12720222	2200MM		22W
	12720243		12720241	12720242	2400MM		24W
	12720303		12720301	12720302	3000MM		30W

★ 电压：12VDC，连接方式：诺米免焊端子线（长度 1.5M，非标配，需单独下单）。NUOMI welding-free patch cords (1.5M, additional purchase is required).



产品特点 FEATURES

- 采用高品质 LED 光源，可调或可选色温（3000K、4000K、6000K）可调亮度，出光均匀，54000 小时超长寿命；
- 采用无铅免焊技术，灯线分离结构；
- 可用于嵌入式层板、立板安装，灯条可裁切；
- 超窄设计 PC 灯罩，无晶点；
- 显指 >90。
- Adjustable or optional color temperature(3000K、4000K、6000K), lighting balance, service life over 54000 hours.
- Unleaded welding-free technology detachable structure between wire and light.
- Built-in type installation, cuttable length, lighting balance.
- PC lampshade, ultra-narrow design and has no crystal points.
- RA>90.

可调灯源色温 COLOR TEMPERATURE ADJUSTABLE

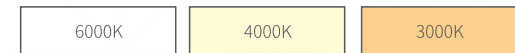

安装说明 INSTALLATION INSTRUCTIONS



技术参数 TECHNICAL DETAILS

Color Temperature 色温 (K)	Item No. 型号	Highclass grey 太郎灰	Highclass grey 波尔多红 (定制)	Highclass grey 香槟金 (定制)	Size (mm) 尺寸 (mm)	Cutout Size (WXDmm) 开槽尺寸 (WXDmm)	Power 功率
可调 3 色温 (3000K- 4000K- 6000K) 通过智能 控制盒 实现 3 色温 自由调节	12710053	12710051	12710052	500MM	8x10mm	5W	
	12710063	12710061	12710062	600MM		6W	
	12710073	12710071	12710072	700MM		7W	
	12710083	12710081	12710082	800MM		8W	
	12710093	12710091	12710092	900MM		9W	
	12710103	12710101	12710102	1000MM		10W	
	12710123	12710121	12710122	1200MM		12W	
	12710143	12710141	12710142	1400MM		14W	
	12710163	12710161	12710162	1600MM		16W	
	12710183	12710181	12710182	1800MM		18W	
	12710203	12710201	12710202	2000MM		20W	
	12710223	12710221	12710222	2200MM		22W	
	12710243	12710241	12710242	2400MM		24W	
	12710303	12710301	12710302	3000MM		30W	

★ 电压：12VDC，连接方式：诺米免焊端子线（长度 1.5M，非标配，需单独下单）。NUOMI welding-free patch cords (1.5M, additional purchase is required).



产品特点 FEATURES

- 采用高品质 LED 光源，可调或可选色温（3000K、4000K、6000K）可调亮度，出光均匀，54000 小时超长寿命；
- 采用无铅免焊技术，灯线分离结构；
- 用于层板后口安装，见光不见灯，光效柔和，可裁切；
- 超窄设计 PC 灯罩，无晶点；
- 显指 >90。
- Adjustable or optional color temperature(3000K、4000K、6000K), lighting balance, service life over 54000 hours.
- Unleaded welding-free technology detachable structure between wire and light.
- Cutable length, concealed installation in the rear of layered board.
- PC lampshade, ultra-narrow design and has no crystal points.
- RA>90.

可调灯源色温 COLOR TEMPERATURE ADJUSTABLE



安装说明 INSTALLATION INSTRUCTIONS

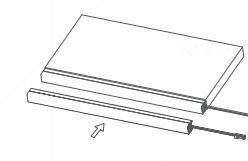
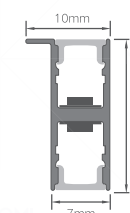

灯具安装在层板边的安装板上

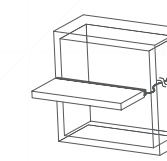

层板（含灯具）安装在柜子里

层板错位 7mm, 背板钻孔出线
depth of layered board shorter 7mm

技术参数 TECHNICAL DETAILS

Color Temperature 色温 (K)	Item No. 型号	Highclass grey 太郎灰	Highclass grey 波尔多红 (定制)	Highclass grey 香槟金 (定制)	Size (mm) 尺寸 (mm)	Power 功率	Remark 备注
可调 3 色温 (3000K- 4000K- 6000K) 通过智能 控制盒 实现 3 色温 自由调节	12740053	12740051	12740052	500MM	10W		
	12740063	12740061	12740062	600MM	12W		
	12740073	12740071	12740072	700MM	14W		
	12740083	12740081	12740082	800MM	16W		
	12740093	12740091	12740092	900MM	18W		
	12740103	12740101	12740102	1000MM	20W		使用二合一 免焊端子线
	12740123	12740121	12740122	1200MM	24W		
	12740143	12740141	12740142	1400MM	28W		
	12740163	12740161	12740162	1600MM	32W		
	12740183	12740181	12740182	1800MM	36W		
	12740203	12740201	12740202	2000MM	40W		
	12740223	12740221	12740222	2200MM	44W		使用两条 免焊端子线
	12740243	12740241	12740242	2400MM	48W		
	12740303	12740301	12740302	3000MM	60W		

★ 电压：12VDC，连接方式：诺米免焊端子线或二合一免焊端子线（长度 1.5M，非标配，需单独下单）。NUOMI welding-free or two-in-one welding-free patch cords (1.5M, additional purchase is required).



产品特点 FEATURES

- 采用高品质 LED 光源，可调或可选色温（3000K、4000K、6000K）可调亮度，出光均匀，54000 小时超长寿命；
- 采用无铅免焊技术，灯线分离结构；
- 用于层板后口安装，见光不见灯，光效柔和，可裁切；
- 超窄设计 PC 灯罩，无晶点；
- 显指 >90。
- Adjustable or optional color temperature(3000K、4000K、6000K), service life over 54000 hours.
- Unleaded welding-free technology detachable structure between wire and light.
- Cutable length,concealed installation in the rear of layered board.
- PC lampshade,ultra-narrow design and has no crystal points.
- RA>90.

可调灯源色温 COLOR TEMPERATURE ADJUSTABLE



安装说明 INSTALLATION INSTRUCTIONS

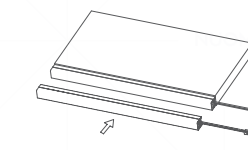
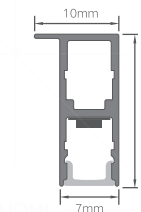

灯具安装在层板边的安装板上

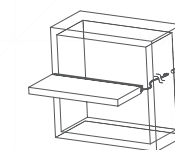

层板（含灯具）安装在柜子里

层板错位 7mm, 背板钻孔出线
depth of layered board shorter 7mm

技术参数 TECHNICAL DETAILS

Color Temperature 色温 (K)	Item No. 型号	Highclass grey 太郎灰	Highclass grey 波尔多红 (定制)	Highclass grey 香槟金 (定制)	Size (mm) 尺寸 (mm)	Power 功率
可调 3 色温 (3000K- 4000K- 6000K) 通过智能 控制盒 实现 3 色温 自由调节	12750053		12750051	12750052	500MM	5W
	12750063		12750061	12750062	600MM	6W
	12750073		12750071	12750072	700MM	7W
	12750083		12750081	12750082	800MM	8W
	12750093		12750091	12750092	900MM	9W
	12750103		12750101	12750102	1000MM	10W
	12750123		12750121	12750122	1200MM	12W
	12750143		12750141	12750142	1400MM	14W
	12750163		12750161	12750162	1600MM	16W
	12750183		12750181	12750182	1800MM	18W
	12750203		12750201	12750202	2000MM	20W
	12750223		12750221	12750222	2200MM	22W
	12750243		12750241	12750242	2400MM	24W
	12750303		12750301	12750302	3000MM	30W

★ 电压：12VDC，连接方式：诺米免焊端子线（长度 1.5M，非标配，需单独下单）。NUOMI welding-free patch cords (1.5M, additional purchase is required).



产品特点 FEATURES

- 采用高品质 LED 光源，可调或可选色温（3000K、4000K、6000K）可调亮度，出光均匀，54000 小时超长寿命；
- 采用无铅免焊技术，灯线分离结构；
- 用于层板后口安装，见光不见灯，光效柔和，可裁切；
- 显指 >90。
- Adjustable or optional color temperature(3000K、4000K、6000K) service life over 54000 hours.
- Unleaded welding-free technology detachable structure between wire and light.
- Cutable length,concealed installation in the rear of layered board.
- RA>90.

可调灯源色温 COLOR TEMPERATURE ADJUSTABLE

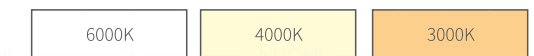

安装说明 INSTALLATION INSTRUCTIONS

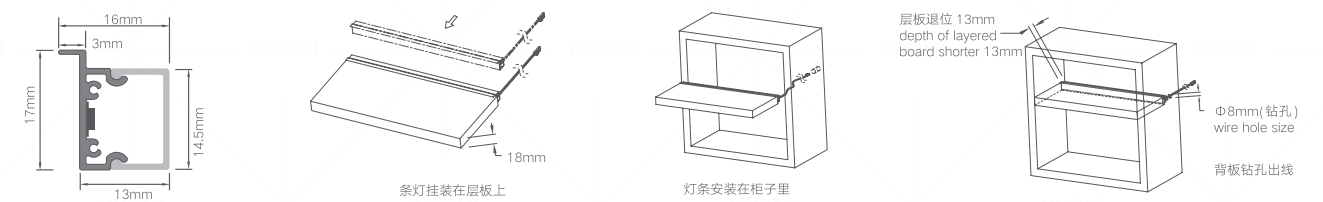

技术参数 TECHNICAL DETAILS

Color Temperature 色温 (K)	Item No. 型号	Highclass grey 太郎灰	Highclass grey 波尔多红 (定制)	Highclass grey 香槟金 (定制)	Size (mm) 尺寸 (mm)	Power 功率
可调 3 色温 (3000K- 4000K- 6000K) 通过智能 控制盒 实现 3 色温 自由调节	12730053		12730051	12730052	500MM	5W
	12730063		12730061	12730062	600MM	6W
	12730073		12730071	12730072	700MM	7W
	12730083		12730081	12730082	800MM	8W
	12730093		12730091	12730092	900MM	9W
	12730103		12730101	12730102	1000MM	10W
	12730123		12730121	12730122	1200MM	12W
	12730143		12730141	12730142	1400MM	14W
	12730163		12730161	12730162	1600MM	16W
	12730183		12730181	12730182	1800MM	18W
	12730203		12730201	12730202	2000MM	20W
	12730223		12730221	12730222	2200MM	22W
	12730243		12730241	12730242	2400MM	24W
	12730303		12730301	12730302	3000MM	30W

★ 电压：12VDC，连接方式：诺米免焊端子线（长度 1.5M，非标配，需单独下单）。NUOMI welding-free patch cords (1.5M, additional purchase is required).

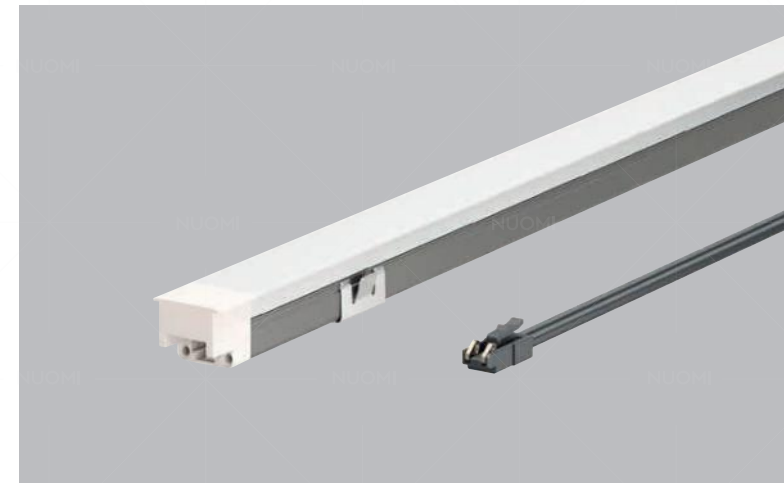

产品特点 FEATURES

- 采用高品质 LED 光源，可调或可选色温 (3000K、4000K、6000K) 可调亮度，出光均匀，54000 小时超长寿命；
- 采用无铅免焊技术，灯线分离结构；
- 可用于嵌入式层板、立板安装，灯条可裁切；
- 显指 >90。
- Adjustable or optional color temperature(3000K、4000K、6000K) lighting balance,service life over 54000 hours.
- Unleaded welding-free technology detachable structure between wire and light.
- Built-in type installation,cutttable length,lighting balance.
- RA>90.

可调灯源色温 COLOR TEMPERATURE ADJUSTABLE



安装说明 INSTALLATION INSTRUCTIONS



技术参数 TECHNICAL DETAILS

Color Temperature 色温 (K)	Item No. 型号	Highclass grey 太郎灰	Highclass grey 波尔多红 (定制)	Highclass grey 香槟金 (定制)	Size (mm) 尺寸 (mm)	Cutout Size (WXDmm) 开槽尺寸 (WXDmm)	Power 功率
可调 3 色温 (3000K- 4000K- 6000K) 通过智能 控制盒 实现 3 色温 自由调节	12790053		12790051	12790052	500MM	11x10mm	5W
	12790063		12790061	12790062	600MM		6W
	12790073		12790071	12790072	700MM		7W
	12790083		12790081	12790082	800MM		8W
	12790093		12790091	12790092	900MM		9W
	12790103		12790101	12790102	1000MM		10W
	12790123		12790121	12790122	1200MM		12W
	12790143		12790141	12790142	1400MM		14W
	12790163		12790161	12790162	1600MM		16W
	12790183		12790181	12790182	1800MM		18W
	12790203		12790201	12790202	2000MM		20W
	12790223		12790221	12790222	2200MM		22W
	12790243		12790241	12790242	2400MM		24W
	12790303		12790301	12790302	3000MM		30W

★ 电压：12VDC，连接方式：诺米免焊端子线（长度 1.5M，非标配，需单独下单）。NUOMI welding-free patch cords (1.5M, additional purchase is required).



产品特点 FEATURES

- 采用高品质 LED 光源，可调或可选色温（3000K、4000K、6000K）可调亮度，出光均匀，54000 小时超长寿命；
- 采用无铅免焊技术，灯线分离结构；
- 三面发光，无光点，适合安装 6-8mm 的玻璃；
- 可用于衣柜、开放柜等后口玻璃层板，可裁切；
- 显指 >90。
- Adjustable or optional color temperature(3000K、4000K、6000K), lighting balance, service life over 54000 hours.
- Unleaded welding-free technology detachable structure between wire and light.
- Three sides lighting, Suitable for 6-8 mm thickness glass.
- Applicable for layered glass of wardrobe or open cabinet, cuttable length.
- RA>90.

可调灯源色温 COLOR TEMPERATURE ADJUSTABLE

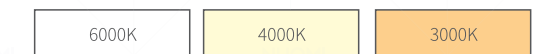

安装说明 INSTALLATION INSTRUCTIONS

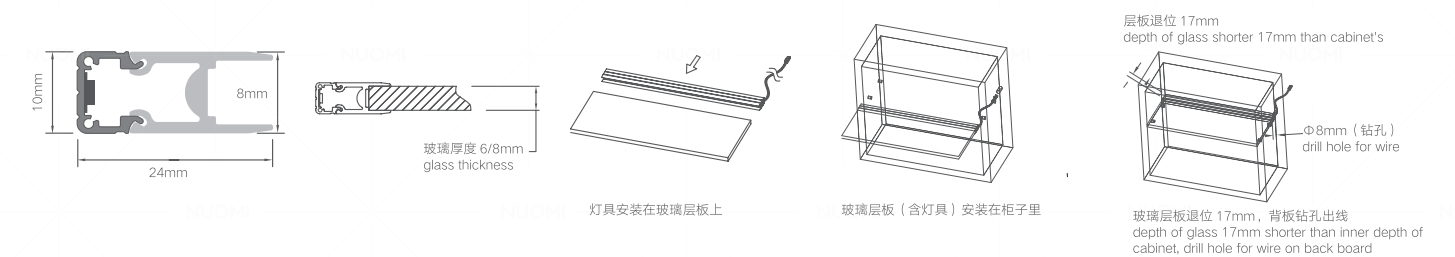

技术参数 TECHNICAL DETAILS

Color Temperature 色温 (K)	Item No. 型号	Highclass grey 太郎灰	Highclass grey 波尔多红 (定制)	Highclass grey 香槟金 (定制)	Size (mm) 尺寸 (mm)	Power 功率
可调 3 色温 (3000K- 4000K- 6000K) 通过智能 控制盒 实现 3 色温 自由调节	12700053		12700051	12700052	500MM	5W
	12700063		12700061	12700062	600MM	6W
	12700073		12700071	12700072	700MM	7W
	12700083		12700081	12700082	800MM	8W
	12700093		12700091	12700092	900MM	9W
	12700103		12700101	12700102	1000MM	10W
	12700123		12700121	12700122	1200MM	12W
	12700143		12700141	12700142	1400MM	14W
	12700163		12700161	12700162	1600MM	16W
	12700183		12700181	12700182	1800MM	18W
	12700203		12700201	12700202	2000MM	20W
	12700223		12700221	12700222	2200MM	22W
	12700243		12700241	12700242	2400MM	24W
	12700303		12700301	12700302	3000MM	30W

★ 电压：12VDC，连接方式：诺米免焊端子线（长度 1.5M，非标配，需单独下单）。NUOMI welding-free patch cords (1.5M, additional purchase is required).

FLEXIBLE LED LIGHTING STRIP

高端灯带

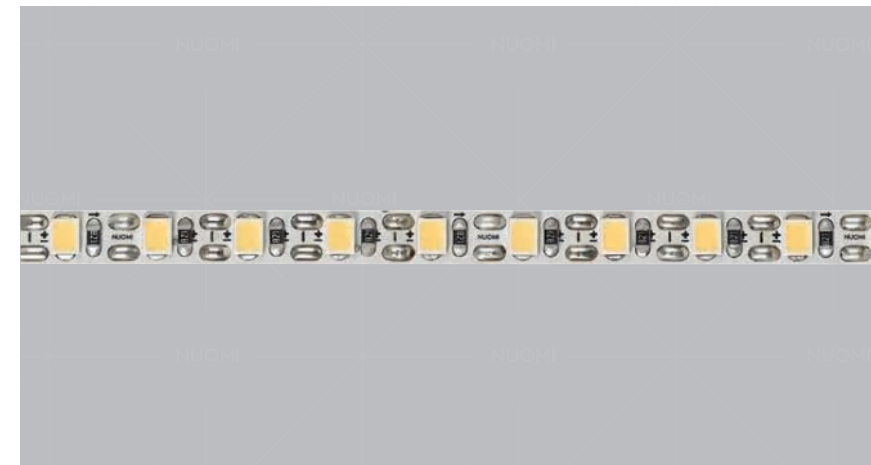

产品特点 FEATURES

- 采用优质芯片光源，双面软电路板，精益贴片，标准生产寿命 70000 小时
- 12V 供电，安全可靠
- 单色灯带 3000K-4000K-6000K 可选色温
- 显指 Ra>90
- Service life over 70000 hours
- Superior LED chip source, bilateral circuit board, precise chip, standard production
- 12V power source, safe and stable

可选灯源色温 COLOR TEMPERATURE



技术参数 TECHNICAL DETAILS

Product Name 产品名称	Item No. 型号	Size (mm) 规格 (mm)	parameter (mm) 参数 (mm)	Color Temperature 色温 (K)
高端单色灯带 3000K	12243425	25M		3000K
高端单色灯带 4000K	12244425	25M	120 灯珠 一灯一剪	4000K
高端三色灯带 3000K-4000K-6000K	12240425	25M		3000K-4000K-6000K

FLEXIBLE LED LIGHTING STRIP

常规灯带

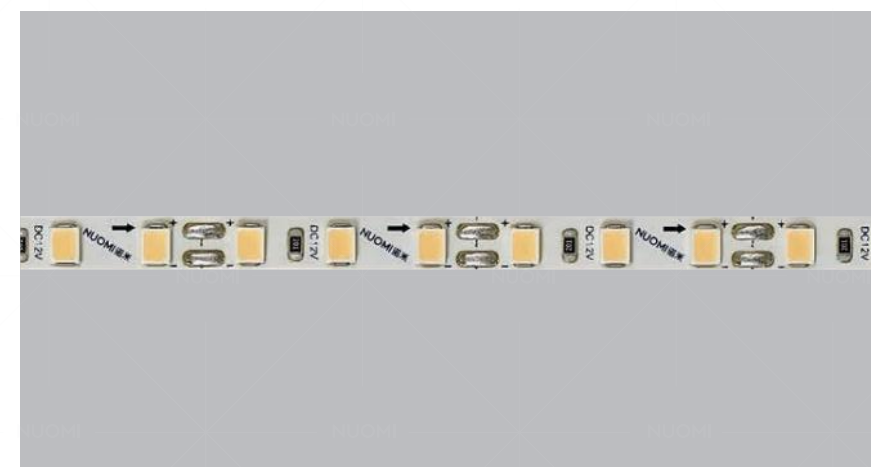

产品特点 FEATURES

- 采用优质芯片光源，双面软电路板，精益贴片，标准生产寿命 70000 小时
- 12V 供电，安全可靠
- 单色灯带 3000K-4000K-6000K 可选色温
- 显指 Ra>90
- Service life over 70000 hours
- Superior LED chip source, bilateral circuit board, precise chip, standard production
- 12V power source, safe and stable

可选灯源色温 COLOR TEMPERATURE



技术参数 TECHNICAL DETAILS

Product Name 产品名称	Item No. 型号	Size (mm) 规格 (mm)	parameter (mm) 参数 (mm)	Color Temperature 色温 (K)
单色灯带 3000K	12243325	25M	120 灯珠	3000K
单色灯带 4000K	12244325	25M	三灯一剪	4000K





内嵌式超窄灯条 -DIY 配件

Color Temperature 色温 (K)	Item No. 型号	Highclass grey 太郎灰	Bordeaux red 波尔多红 (定制)	Champagne golden 香槟金 (定制)	Size (mm) 尺寸 (mm)	备注
	铝型材 + 灯罩	12710003	12710001	12710002	3000MM	/
	堵头	12810003A	12810001A	12810002A	PC 材质	/
	免焊堵头	12810003B	12810001B	12810002B	PC 材质	/

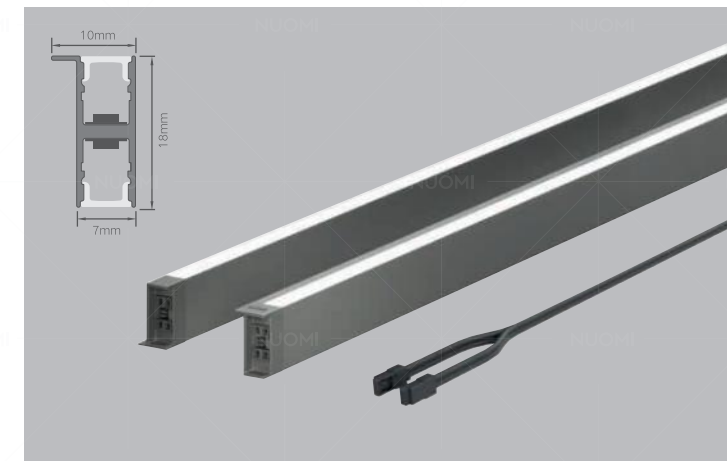

明装后口上下发光灯条 -DIY 配件

Color Temperature 色温 (K)	Item No. 型号	Highclass grey 太郎灰	Bordeaux red 波尔多红 (定制)	Champagne golden 香槟金 (定制)	Size (mm) 尺寸 (mm)	备注
	铝型材 + 灯罩	12740003	12740001	12740002	3000MM	/
	左堵头	12850003A	12850001A	12850002A	PC 材质	与 1286 共用
	免焊右堵头	12850003B	12850001B	12850002B	PC 材质	与 1286 共用



嵌入式斜射灯条 -DIY 配件

Color Temperature 色温 (K)	Item No. 型号	Highclass grey 太郎灰	Bordeaux red 波尔多红 (定制)	Champagne golden 香槟金 (定制)	Size (mm) 尺寸 (mm)	备注
	铝型材 + 灯罩	12720003	12720001	12720002	3000MM	/
	堵头	12820003A	12820001A	12820002A	PC 材质	与 1283 共用
	免焊堵头	12820003B	12820001B	12820002B	PC 材质	与 1283 共用

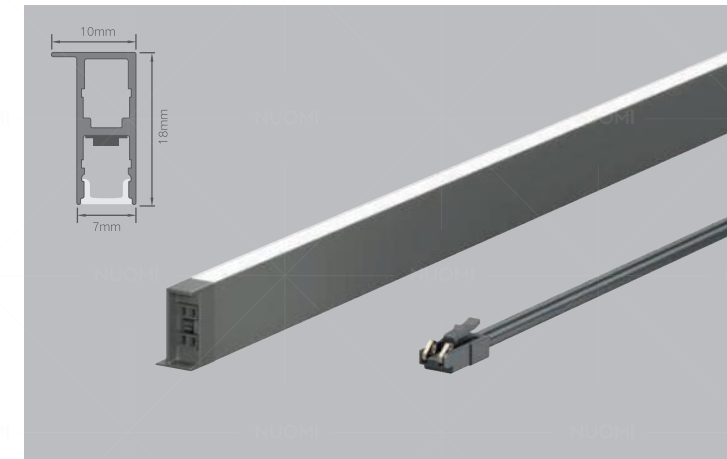

明装后口下发光灯条 -DIY 配件

Color Temperature 色温 (K)	Item No. 型号	Highclass grey 太郎灰	Bordeaux red 波尔多红 (定制)	Champagne golden 香槟金 (定制)	Size (mm) 尺寸 (mm)	备注
	铝型材 + 灯罩	12750003	12750001	12750002	3000MM	/
	左堵头	12850003A	12850001A	12850002A	PC 材质	与 1285 共用
	免焊右堵头	12850003B	12850001B	12850002B	PC 材质	与 1285 共用

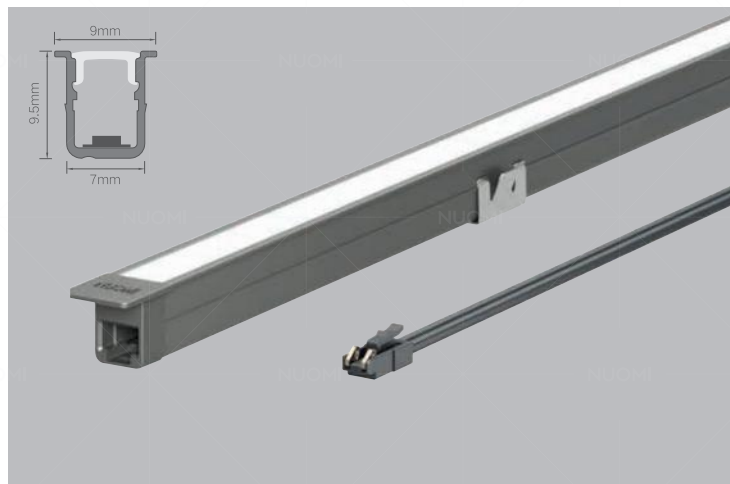

嵌入式灯条 (铝材翻边) -DIY 配件

Color Temperature 色温 (K)	Item No. 型号	Highclass grey 太郎灰	Bordeaux red 波尔多红 (定制)	Champagne golden 香槟金 (定制)	Size (mm) 尺寸 (mm)	备注
	铝型材 + 灯罩	12730003	12730001	12730002	3000MM	/
	堵头	12820003A	12820001A	12820002A	PC 材质	与 1282 共用
	免焊堵头	12820003B	12820001B	12820002B	PC 材质	与 1282 共用

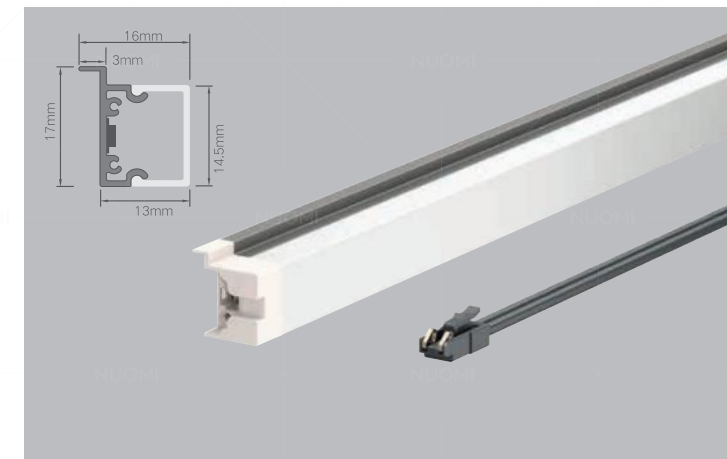

免安装后口层板灯 -DIY 配件

Color Temperature 色温 (K)	Item No. 型号	Highclass grey 太郎灰	Bordeaux red 波尔多红 (定制)	Champagne golden 香槟金 (定制)	Size (mm) 尺寸 (mm)	备注
	铝型材 + 灯罩	12730003	12730001	12730001	3000MM	/
	左堵头	12873001B	12873001B	12873001B	乳白色	/
	免焊右堵头	12873001A	12873001A	12873001A	乳白色	/



嵌入式灯条 (灯罩翻边) -DIY 配件

Color Temperature 色温 (K)	Item No. 型号	Highclass grey 太郎灰	Bordeaux red 波尔多红 (定制)	Champagne golden 香槟金 (定制)	Size (mm) 尺寸 (mm)	备注
	铝型材 + 灯罩	12790003	12790001	12790002	3000MM	/
	免焊堵头	12843001A	12843001A	12843001A	乳白色	/

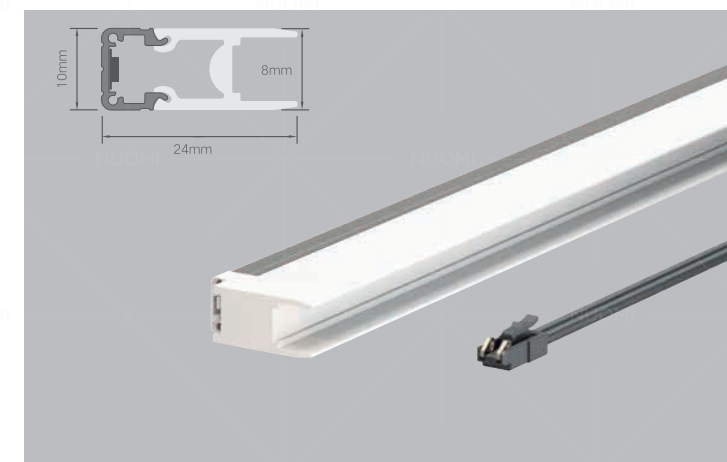

玻璃层板灯条 -DIY 配件

Color Temperature 色温 (K)	Item No. 型号	Highclass grey 太郎灰	Bordeaux red 波尔多红 (定制)	Champagne golden 香槟金 (定制)	Size (mm) 尺寸 (mm)	备注
	铝型材 + 灯罩	12700003	12700001	12700002	3000MM	/
	免焊堵头	12883001A	12883001A	12883001A	乳白色	/

CONCISE AND NEAT

ARES LIGHT

阿瑞斯系列

The line and surface run through as a whole, conveying a more restrained and calm atmosphere. Inverted and elegant are written into the space, with its own gentle lighting, making the visual presentation more concise and neat.

线面贯穿为一体，传递一种更为克制、沉稳的氛围。

将内敛与优雅写入空间，自带温雅的灯光，让视觉呈现更为简净、利落。





ARES LIGHT

阿瑞斯系列

Clean and comfortable space, more full and orderly combination of different modules, breaking the monotony of the plane, bringing rhythm and rhythm is more undulating.

干净而舒适的空间，不同模块组合更显饱满有序，突破了平面的单调，带来更具起伏的韵律与节奏。



BRIGHT AND ELEGANT



ARES LIGHT

- Minimalism ultra narrow strip lights, follow current trend, minimalism light luxury style.
- Ultra narrow luminous surface area 5.8Mm.
- High quality pc lampshade, uv resistant, lighting balance, soft for eyes.

阿瑞斯系列

- 迎合当下流行的极简轻奢风格需要的极简超窄灯条；
- 极简超窄发光面低至 5.8mm，行业极窄；
- 抗 UV 高品质 PC 灯罩，光线均匀无晶点，柔和不刺眼。





产品特点 FEATURES

- 采用高品质 LED 光源，可调或可选色温（3000K、4000K、6000K），可调亮度，出光均匀，70000 小时超长寿命；
- 用于层板后口安装，见光不见灯，光效柔和，可裁切；
- 超薄设计 PC 灯罩，无晶点；
- 显指 Ra>90。
- Adjustable or Optional color temperature (3000K、4000K、6000K) , Adjustable brilliance, lighting balance, service life over 70000 hours.
- Cutable length, concealed installation in the rear of layered board.
- PC lampshade, ultra-narrow design and has no crystal points.
- Ra>90.

可调灯源色温 COLOR TEMPERATURE ADJUSTABLE



安装说明 INSTALLATION INSTRUCTIONS

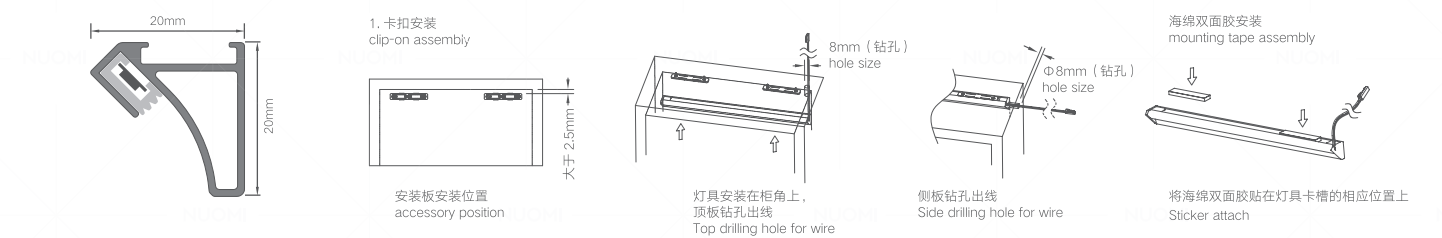

技术参数 TECHNICAL DETAILS

Color Temperature 色温 (K)	Item No. 型号	Size (mm) 尺寸 (mm)	Power 功率	Remark 备注	
可调色温 (3000K、4000K、6000K)	Highclass grey 太郎灰	Matte black 哑黑			
	12360043	12360045	400mm	4W	
	12360063	12360065	600mm	6W	
	12360083	12360085	800mm	8W	
	12360103	12360105	1000mm	10W	
	12360123	12360125	1200mm	12W	
	12360153	12360155	1500mm	15W	两端焊线配两个堵头两个底座 both ends bonding wire with 2pcs of end cap
	12360183	12360185	1800mm	18W	
3000K	12360283	12360285	2800mm	28W	
	12363043	12363045	400mm	4W	
	12363063	12363065	600mm	6W	
	12363083	12363085	800mm	8W	
	12363103	12363105	1000mm	10W	
	12363123	12363125	1200mm	12W	
	12363153	12363155	1500mm	15W	两端焊线配两个堵头两个底座 both ends bonding wire with 2pcs of end cap
	12363183	12363185	1800mm	18W	
4000K	12363283	12363285	2800mm	28W	
	12364043	12364045	400mm	4W	
	12364063	12364065	600mm	6W	
	12364083	12364085	800mm	8W	
	12364103	12364105	1000mm	10W	
	12364123	12364125	1200mm	12W	
同上	12364153	12364155	1500mm	15W	两端焊线配两个堵头两个底座 both ends bonding wire with 2pcs of end cap
	12364183	12364185	1800mm	18W	
	12364283	12364285	2800mm	28W	
	同上	12369991	波尔多红 bordeaux red	/	/
同上	12369992	香槟金 champagne gold	/	/	定制 custom size

★ 电压：12VDC，连接方式：超薄导线 Ultra-thin wire (0.6M) + 延长线 Lengthen wire (2M)。





产品特点 FEATURES

- 采用高品质 LED 光源，可调或可选色温（3000K、4000K、6000K），可调亮度，出光均匀，70000 小时超长寿命；
- 向内发光，见光不见灯，光效柔和，可裁切；
- 超窄设计 PC 灯罩，无晶点；
- 显指 Ra>90。
- Adjustable or Optional color temperature (3000K、4000K、6000K) , Adjustable brilliance, lighting balance, service life over 70000 hours.
- Cutable length, concealed installation, Lighting inwards.
- PC lampshade, ultra-narrow design and has no crystal points.
- Ra>90.

可调灯源色温 COLOR TEMPERATURE ADJUSTABLE



安装说明 INSTALLATION INSTRUCTIONS

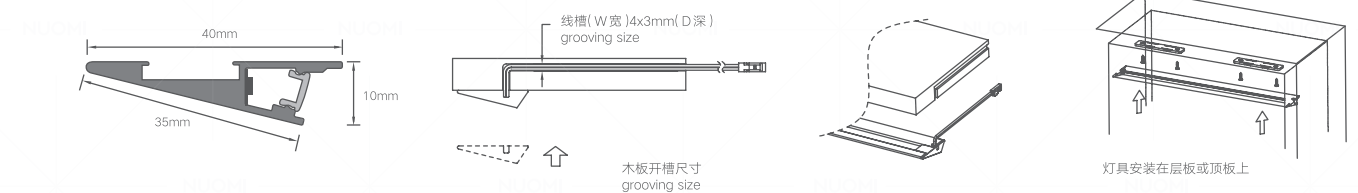

技术参数 TECHNICAL DETAILS

Color Temperature 色温 (K)	Item No. 型号	Size (mm) 尺寸 (mm)	Power 功率	Remark 备注
可调色温 (3000K、4000K、6000K)	Highclass grey 太郎灰	Matte black 哑黑		
	12330043	12330045	400mm	4W
	12330063	12330065	600mm	6W
	12330083	12330085	800mm	8W
	12330103	12330105	1000mm	10W
	12330123	12330125	1200mm	12W
	12330153	12330155	1500mm	15W
	12330183	12330185	1800mm	18W
	12330283	12330285	2800mm	28W
	12330403	12330405	4000mm	40W
3000K	12333043	12333045	400mm	4W
	12333063	12333065	600mm	6W
	12333083	12333085	800mm	8W
	12333103	12333105	1000mm	10W
	12333123	12333125	1200mm	12W
	12333153	12333155	1500mm	15W
	12333183	12333185	1800mm	18W
	12333283	12333285	2800mm	28W
4000K	12334043	12334045	400mm	4W
	12334063	12334065	600mm	6W
	12334083	12334085	800mm	8W
	12334103	12334105	1000mm	10W
	12334123	12334125	1200mm	12W
	12334153	12334155	1500mm	15W
	12334183	12334185	1800mm	18W
	12334283	12334285	2800mm	28W
同上	12339991	波尔多红 bordeaux red	/	/
同上	12339992	香槟金 champagne gold	/	/

★ 电压：12VDC，连接方式：杜邦端子线（1.5M）。Dupont wire（1.5M）。



产品特点 FEATURES

- 采用高品质 LED 光源，可调或可选色温（3000K、4000K、6000K），可调亮度，出光均匀，70000 小时超长寿命；
- 标配超薄导线，走线不再钻孔外露，可裁切；
- 超窄设计 PC 灯罩，无晶点；
- 显指 Ra>90。
- Adjustable or Optional color temperature (3000K、4000K、6000K) , Adjustable brilliance, lighting balance, service life over 70000 hours.
- Ultra-thin wire, no need drilling hole, Cuttable length.
- PC lampshade, ultra-narrow design and has no crystal points.
- Ra>90.

可调灯源色温 COLOR TEMPERATURE ADJUSTABLE



安装说明 INSTALLATION INSTRUCTIONS

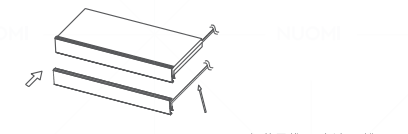
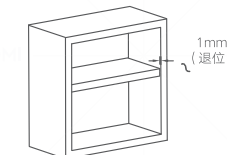
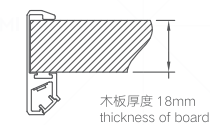
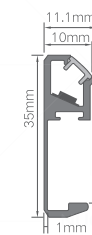

灯具安装于层板 front of layered board

技术参数 TECHNICAL DETAILS

Color Temperature 色温 (K)	Item No. 型号		Size (mm) 尺寸 (mm)	Power 功率	Remark 备注
可调色温 (3000K、4000K、6000K)	Highclass grey 太郎灰	Matte black 哑黑			
	12370043	12370045	400mm	4W	
	12370063	12370065	600mm	6W	
	12370083	12370085	800mm	8W	
	12370103	12370105	1000mm	10W	
3000K	12370123	12370125	1200mm	12W	两端焊线 both ends bonding wire
	12373043	12373045	400mm	4W	
	12373063	12373065	600mm	6W	
	12373083	12373085	800mm	8W	
	12373103	12373105	1000mm	10W	
4000K	12373123	12373125	1200mm	12W	两端焊线 both ends bonding wire
	12374043	12374045	400mm	4W	
	12374063	12374065	600mm	6W	
	12374083	12374085	800mm	8W	
	12374103	12374105	1000mm	10W	
同上	12374123	12374125	1200mm	12W	两端焊线 both ends bonding wire
	12379991	波尔多红 bordeaux red	/	/	定制 custom size
	12379992	香槟金 champagne gold	/	/	定制 custom size

★ 电压：12VDC，连接方式：超薄导线 Ultra-thin wire (0.6M) + 延长线 Lengthen wire (2M)。

BRAND-NEW CONNOTATION

SENSORY LIGHT

感应式灯光

Highly beautiful intelligent sensor light, with no-touch one-second critical sensing distance, can be used in many occasions, reconstruct life scenes, discover the essence of happiness from the light, and make life easier and more convenient.

高颜值的智能感应灯光，无接触一秒临界感应距离，满足多种场合使用，重构生活场景，从灯光中发现幸福的本质，让生活变得更简单方便。





SENSORY LIGHT

感应式灯光

The design is human-centric, with beautiful lines that can be easily integrated into different styles of home life, easily control any space, and restore the purity and beauty of life.

设计以人为核心，富有美感的线条，能够轻易融入不同风格的家居生活之中，轻松驾驭任意空间，还原生活的纯粹与美好。



Convenient wireless installation, no worries about wiring. A variety of inductive switching methods improve all inconveniences and open up a more flexible home life for you.

便捷无线安装，无走线顾虑。多种感应开关方式，改善一切不便，为你打开更灵活的居家生活。



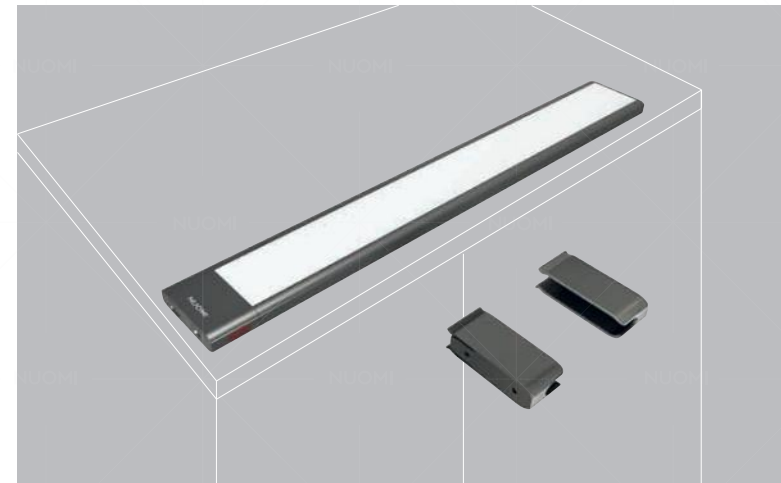

产品特点 FEATURES

- 采用高品质 LED 光源，可选色温（4000K），可调亮度，出光均匀，70000 小时超长寿命；
- 超长续航，磁吸 / 卡扣安装，门控感应；
- 采用日本进口三菱导光板，出光均匀无光斑；
- 左右门控感应开关，便于左右安装；
- 显指 Ra>90。
- Optional color temperature, adjustable brilliance, lighting balance, service life over 70000 hours.
- Ultra-long life battery, magnetic or clip-on type of installation.
- LGP imported from mitsubishi, lighting balance.
- Double door-control switch (left and right).
- Ra>90.

可选灯源色温 COLOR TEMPERATURE

4000K

安装说明 INSTALLATION INSTRUCTIONS

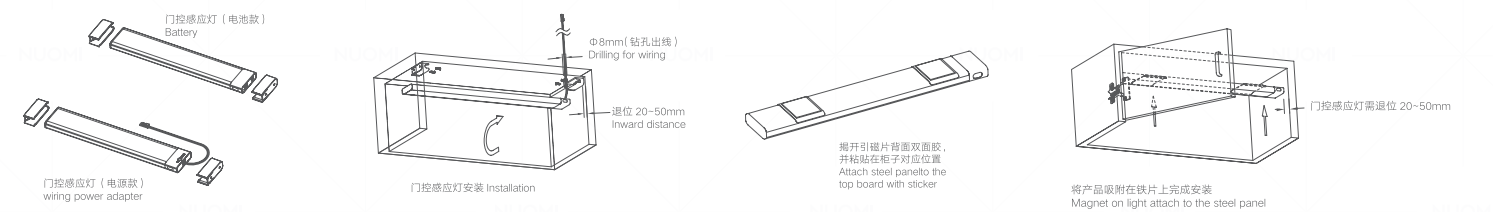

技术参数 TECHNICAL DETAILS

Color Temperature 色温 (K)	Product Name 产品名称	Item No. 型号	Size (mm) 尺寸 (mm)	Power 功率	Sensor switch 感应开关	
4000K	电池款门控感应灯 Battery type	Champagne golden 香槟金	Highclass grey 太郎灰	Matte black 哑黑	413mm	1.8W
		12534042	12534043	12534045	563mm	2.4W
		12534062	12534063	12534065	663mm	2.8W
		12534072	12534073	12534075	763mm	3.2W
		12534082	12534083	12534085	863mm	3.6W
	电源款门控感应灯 Battery type	12534092	12534093	12534095	413mm	4.5W
		12544042	12544043	12544045	563mm	6W
		12544062	12544063	12544065	663mm	7W
		12544072	12544073	12544075	763mm	8W
		12544082	12544083	12544085	863mm	9W

★ 电压：5VDC（电池款）/12VDC（电源款），连接方式：电池供电（电池款）/杜邦端子线（1.5M）。Dupont wire（1.5M）。





产品特点 FEATURES

- 采用高品质 LED 光源, 可调色温 (3000K、4000K、6000K)、亮度, 出光均匀, 70000 小时超长寿命;
- 磁吸便捷安装, 手扫感应, 随手取下当夜灯;
- 采用日本进口三菱导光板, 出光均匀无光斑;
- 显指 Ra>90。
- Adjustable light color temperature and brilliance, lighting balance, service life over 70000 hours.
- Magnet type installation, hand sensor switch, convenient disassembly.
- LGP imported from mitsubishi, lighting balance.
- Ra>90.

可调灯源色温 COLOR TEMPERATURE ADJUSTABLE



安装说明 INSTALLATION INSTRUCTIONS

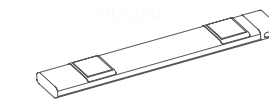
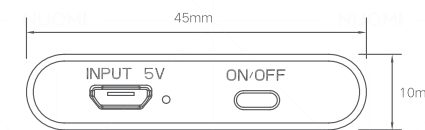

揭开引磁片背面双面胶, 并粘贴在柜子上对应位置
Attach steel panel to the top board with sticker

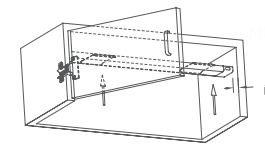

将产品吸附在铁片上完成安装
Attach light with magnet to steel panel

技术参数 TECHNICAL DETAILS

Color Temperature 色温 (K)	Item No. 型号		Size (mm) 尺寸 (mm)	Power 功率	Sensor switch 感应开关	
可调色温 (3000K、4000K、6000K)	Champagne golden 香槟金	Highclass grey 太郎灰	Matte black 哑黑	300mm	1.2W	带手扫感应开关 hand sweep sensor switch
	12550032	12550033	12550035	500mm	2W	
	12550082	12550083	12550085	800mm	3.2W	

★ 电压: 5VDC (电池款) / 12VDC (电源款), 连接方式: 电池供电 (电池款) / 杜邦端子线 (1.5M) Dupont wire (1.5M)



产品特点 FEATURES

- 采用高品质 LED 光源, 可选色温 (4000K), 可调亮度, 出光均匀, 70000 小时超长寿命;
- 磁吸便捷安装, 人体感应, 随手取下当夜灯;
- 采用日本进口三菱导光板, 出光均匀无光斑;
- 感应距离 3 米, 延时输出 30 秒;
- 显指 Ra>90。
- Optional color temperature, adjustable brilliance, lighting balance, service life over 70000 hours.
- Magnet type installation, body sensor switch, convenient disassembly.
- LGP imported from mitsubishi, lighting balance.
- Max sensing distance 3m, output delay 30 seconds .
- Ra>90.

可选灯源色温 COLOR TEMPERATURE

4000K

安装说明 INSTALLATION INSTRUCTIONS

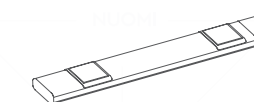
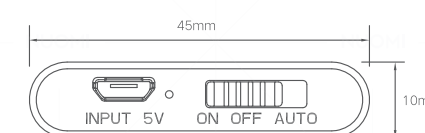

揭开引磁片背面双面胶, 并粘贴在柜子对应位置
Attach steel panel to the top board with sticker

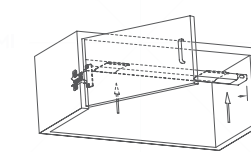

将产品吸附在铁片上完成安装
Attach light with magnet to steel panel

技术参数 TECHNICAL DETAILS

Color Temperature 色温 (K)	Item No. 型号		Size (mm) 尺寸 (mm)	Power 功率	Sensor switch 感应开关	
4000K	Champagne golden 香槟金	Highclass grey 太郎灰	Matte black 哑黑			
	12564032	12564033	12550035	300mm	1.2W	
	12564052	12564053	12550055	500mm	2W	
	12564082	12564083	12550085	800mm	3.2W	
						人体红外感应开关 body infrared sensor switch

★ 电压: 5VDC, 连接方式: 电池供电。battery power supply.

BACK TO CLASSIC

COMMON LIGHT

常规系列

Capture inspiration from the light culture, make it dance freely in the environment, and then grow into a part of the home temperament, between the virtual and the real, free and comfortable. Add a little light to life, so that the home has the magic to smooth out the folds of life.

从光文化中捕捉灵感，使其在环境中自由舞动，
继而生长成为家居气质的一部分，虚实之间，自由淡然。
为生活加一点光，让家拥有抚平生活褶皱的魔力。



COMMON SERIES

常规系列



The texture of the material is mapped to the warm and natural beauty, giving the space a natural stretch and relaxation, bringing a more comfortable life experience.

材质的肌理被映射出温暖的自然美感，让空间多了一份自然的舒展与放松，带来更为舒适的生活体验。



产品特点 FEATURES

- 采用高品质 LED 光源, 可调色温 (3000K、4000K、6000K)、亮度, 出光均匀, 70000 小时超长寿命;
- 用作橱柜、衣柜踢脚板, 向下发光, 见光不见灯, 可裁切;
- 防水灯条;
- 显指 Ra>90。
- Adjustable light color temperature and brilliance, lighting balance, service life over 70000 hours.
- Cuttable length, lighting downward
Applicable for cabinet, wardrobe baseboard.
- Waterproof.
- Ra>90.

可调灯源色温 COLOR TEMPERATURE ADJUSTABLE



安装说明 INSTALLATION INSTRUCTIONS

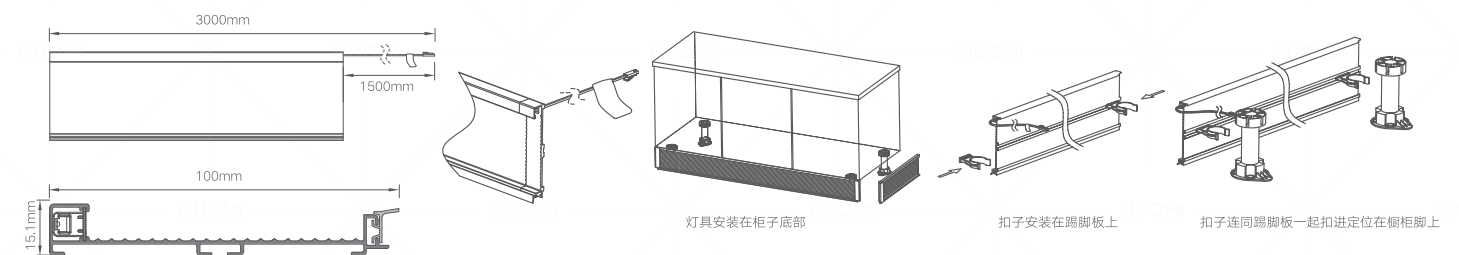

技术参数 TECHNICAL DETAILS

Color Temperature 色温 (K)	Item No. 型号	Aluminium color 铝材颜色	Size (mm) 尺寸 (mm)	Power 功率	Remark 备注	Sensor switch 感应开关
	12650302	香槟金 champagne gold	3000mm	10W/m 米		
可调色温 (3000K、4000K、6000K)	12650303	太郎灰 highclass grey	3000mm	10W/m 米	每包 10 根, 两端焊线, 两副万能转角	无感应开关 (可外接) no sensor switch (external available)
	12650305	哑黑 matte black	3000mm	10W/m 米		
	12650311	波尔多红 Highclass grey	3000mm	10W/m 米		
/	12650312	香槟金 champagne gold	3000mm	10W/m 米	踢脚板灯配件套装	无感应开关 (可外接) no sensor switch (external available)
	12650313	太郎灰 highclass grey	3000mm	10W/m 米		

★ 电压: 12VDC, 连接方式: 杜邦端子线 (1.5M)。Dupont wire (1.5M)。



产品特点 FEATURES

- 采用高品质 LED 光源, 可调色温 (3000K、4000K、6000K)、亮度, 出光均匀, 70000 小时超长寿命;
- 超薄设计, 灯与层板无缝隙完美融合, 嵌入式简易安装, 开孔直径为 62MM;
- 底座明装, 无需开孔;
- 外观精致美观;
- 显指 Ra>90.
- Adjustable light color temperature and brilliance, lighting balance, service life over 70000 hours.
- Ultra-thin design, built-in mounted.
- Hole diameter 62mm.
- No need drilling hole, surface mounted.
- Ra>90.

可调光源色温 COLOR TEMPERATURE ADJUSTABLE

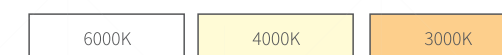

嵌入式圆形射灯 BUILT-IN ROUND SPOTLIGHT

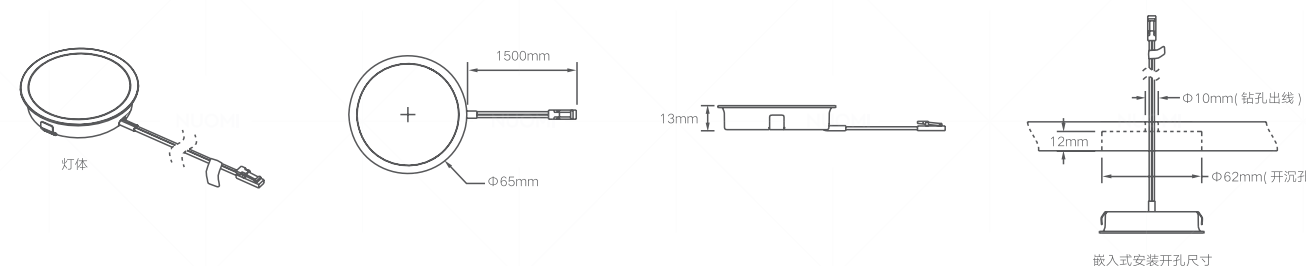

技术参数 TECHNICAL DETAILS

Color Temperature 色温 (K)	Item No. 型号	Aluminium color 铝材颜色	Size (mm) 尺寸 (mm)	Power 功率	Sensor switch 感应开关
可调色温 (3000K、4000K、6000K)	12660018	哑银 silver	Ø 64.5xH13	2W	无感应开关 (可外接) no sensor switch (external available)

明装圆形射灯外壳 SURFACE MOUNTED ROUND SPOTLIGHT

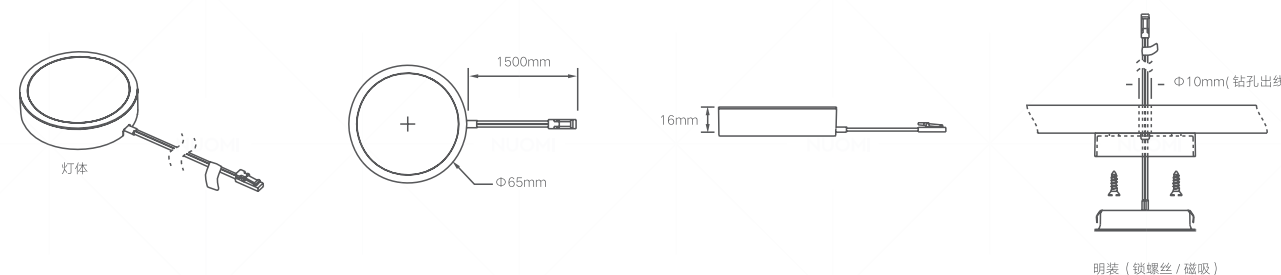

技术参数 TECHNICAL DETAILS

Color Temperature 色温 (K)	Item No. 型号	Aluminium color 铝材颜色	Size (mm) 尺寸 (mm)	Power 功率	Sensor switch 感应开关
可调色温 (3000K、4000K、6000K)	12660028	哑银 silver	Ø 64.5xH13	2W	无感应开关 (可外接) no sensor switch (external available)

★ 电压: 12VDC, 连接方式: 杜邦端子线 (1.5M)。Dupont wire (1.5M)。

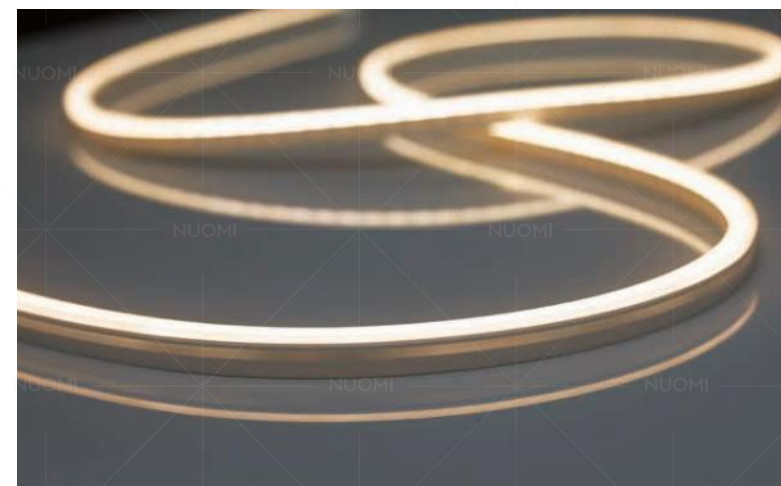

产品特点 FEATURES

- 采用高品质 LED 光源，可调或可选色温（3000K、4000K、6000K），可调亮度，出光均匀，70000 小时超长寿命；
- 12V 供电，安全可靠，可裁切；
- 双色灯带 3000K-4000K-6000K 可调色温；
- 显指 Ra>90。
- Adjustable or Optional color temperature (3000K、4000K、6000K), adjustable brilliance, lighting balance, service life over 70000 hours.
- Superior LED chip source, bilateral circuit board, precise chip, standard production; cuttable length.
- 12V power source, safe and stable.
- Ra>90.

可调灯源色温 COLOR TEMPERATURE ADJUSTABLE

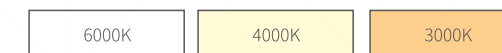

安装说明 INSTALLATION INSTRUCTIONS

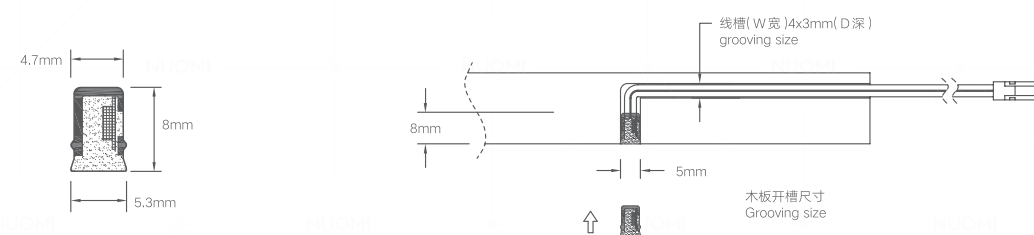

技术参数 TECHNICAL DETAILS

Color Temperature 色温 (K)	Item No. 型号	Size (mm) 尺寸 (mm)	Power 功率	Remark 备注	Sensor switch 感应开关
可调色温 (3000K、4000K、6000K)	12670049	400mm	4W		
	12670069	600mm	6W		
	12670089	800mm	8W		
	12670109	1000mm	10W		恒压驱动 Constant voltage driver
	12670129	1200mm	12W		
	12670289	2800mm	28W	两端焊线 both ends bonding wire	
3000K	12670509	5000mm	50W		
	12673049	400mm	4W		
	12673069	600mm	6W		
	12673089	800mm	8W		
	12673109	1000mm	10W		恒压驱动 Constant voltage driver
	12673129	1200mm	12W		
4000K	12673289	2800mm	28W	两端焊线 both ends bonding wire	
	12673509	5000mm	50W		
	12674049	400mm	4W		
	12674069	600mm	6W		
	12674089	800mm	8W		
	12674109	1000mm	10W		恒压驱动 Constant voltage driver
	12674129	1200mm	12W		
	12674289	2800mm	28W	两端焊线 both ends bonding wire	
	12674509	5000mm	50W		

★ 电压：12VDC，连接方式：杜邦端子线（1.5M）。Dupont wire（1.5M）。

DEFINITION OF QUALITY

SMART CONTROL SYSTEM AND ACCESSORIES

智能控制系统及配件

The ultra-thin design concept makes better use of the space in the cabinet, excellent and precise craftsmanship, and finds a balance between performance and beauty. The thickness of 16.5mm shows unparalleled slim fashion, easy to hide in the cabinet, and gives a visually neat look.

超薄设计理念，将柜内空间利用更充分，卓越精准工艺，在性能与美感之间找到平衡，16.5mm厚度展现无可比拟的纤薄时尚，易于隐藏于柜内，赋予视觉上整洁的观感。





SMART CONTROL SYSTEM AND ACCESSORIES

智能控制系统及配件

Convenient wireless installation, support wireless touch sensing, wireless human body sensing, wireless door control or hand sweep (integrated switchable) sensing, etc. Master the core technology, create an intelligent living space, let you enjoy a convenient life.

便捷无线安装，支持无线触摸感应、无线人体感应、无线门控或手扫（集成可切换）感应等。核心科技傍身，打造智能化生活空间，让你悦享便捷人生。

ULTRA-THIN CONSTANT VOLTAGE POWER SOURCE WITH SMART CONTROL

高端 LED 智能超薄恒压电源



产品特点 CHARACTERISTICS

- 产品通过 CCC 认证, 符合 UL、CE、KC 等相关标准及美国能源之星 - 固态照明 SSL 灯具之要求;
- 安全, 系统具有轻载, 过载保护功能, 确保电源工作稳定, 电源有较高的效率, 发热小, 元器件采用品牌器件, 质量稳定;
- 抗干扰和抗过载能力强;
- 标配无线接收器, 可搭配无线开关使用, 可调色温, 亮度;
- 16.5mm 超薄设计, 空间利用更充沛。

- 3C certificate, meet UL, CE, KC standard.
- Overload protection, stable power supply.
- Strong anti-interference capability.
- Standard equipped with wireless receiver, capable for wireless switch, adjusting color temperature and brilliance.
- 16.5mm thickness, ultra-thin.

安装说明 INSTALLATION INSTRUCTIONS

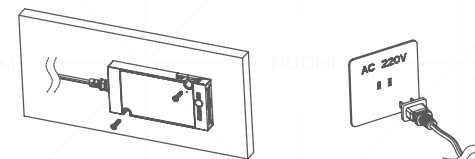

建议此恒压控制装置用螺丝固定在柜体或墙壁上
fix the power adapter on the cabinet board or wall

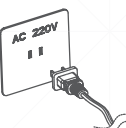

接 220V 电源
connect to 220V power source

技术参数 TECHNICAL DETAILS

Item No. 型号	Size (mm) 尺寸 (mm)	Color 颜色	Ac Input 交流输入	Voltage Output 电压输出	Power 功率	output control mode 输出控制方式
12201020	L100xW68xH16.5mm	湖蓝色 blue	200-240Vac ~ 0.2A 50/60HZ PF ≥ 0.5	12V/1.67A	20W	有线或无线 wire or wireless
12201030	L160xW68xH16.5mm	湖蓝色 blue	200-240Vac ~ 0.2A 50/60HZ PF ≥ 0.9	12V/2.5A	30W	
12201060	L215xW68xH16.5mm	湖蓝色 blue	200-240Vac ~ 0.38A 50/60HZ PF ≥ 0.9	12V/5A	60W	
12201080	L215xW68xH16.5mm	湖蓝色 blue	200-240Vac ~ 0.55A 50/60HZ PF ≥ 0.9	12V/6.67A	80W	

ULTRA-THIN CONSTANT VOLTAGE POWER SOURCE WITH SMART CONTROL

LED 智能超薄恒压电源



产品特点 CHARACTERISTICS

- 安全, 系统具有轻载, 过载保护功能, 确保电源工作稳定, 电源有较高的效率, 发热小, 元器件采用品牌器件, 质量稳定;
- 结构简单, 无众多的元器件, 可靠性相当高稳压范围相当宽, 抗干扰和抗过载能力强;
- 16.5mm 超薄设计, 空间利用更充沛。

- Overload protection, stable power supply.
- Strong anti-interference capability.
- 16.5mm thickness, ultra-thin.

安装说明 INSTALLATION INSTRUCTIONS

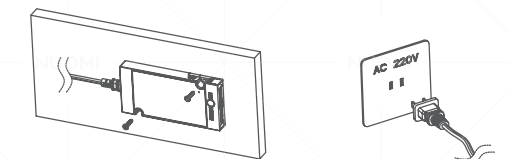

建议此恒压控制装置用螺丝固定在柜体或墙壁上
fix the power adapter on the cabinet board or wall

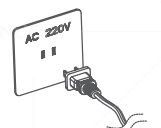

接 220V 电源
connect to 220V power source

技术参数 TECHNICAL DETAILS

Item No. 型号	Size (mm) 尺寸 (mm)	Ccolor 颜色	Ac Input 交流输入	Voltage Output 电压输出	Power 功率	output control mode 输出控制方式
12202024	L100xW68xH16.5mm	黑色 Black	200-240Vac ~ 0.3A 50/60HZ PF ≥ 0.5	12V/2A	24W	有线或无线 wire or wireless
12202036	L140xW68xH16.5mm	黑色 Black	200-240Vac ~ 0.45A 50/60HZ PF ≥ 0.5	12V/3A	36W	
12202060	L160xW68xH16.5mm	黑色 Black	200-240Vac ~ 0.7A 50/60HZ PF ≥ 0.5	12V/5A	60W	
12202100	L215xW68xH16.5mm	黑色 Black	200-240Vac ~ 1.1A 50/60HZ PF ≥ 0.5	12V/8.33A	100W	

WIRELESS TOUCH SENSOR SIGNAL SWITCH

无线触摸感应信号开关（升级版本）



产品特点 CHARACTERISTICS

- 无需布线，便捷安装；
- 365 天超长续航，纽扣电池简单更换；
- 触摸发射信号实现无线操控；
- 符合安全，环保 RoHS。

- Wireless.
- Over 365 days ultra-long life battery,easy to assemble.
- Touch control, wireless.
- Safe and stable, meet standard of RoHS.

安装说明 INSTALLATION INSTRUCTIONS

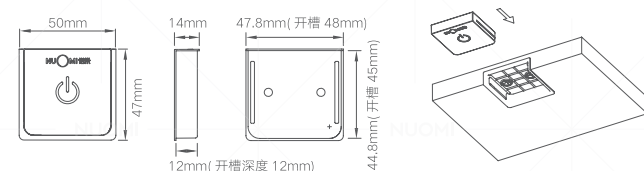

技术参数 TECHNICAL DETAILS

Item No. 型号	12221001
Size (mm) 尺寸	Φ35X12.6mm 面盖 Cover(40X40mm)
Input voltage 输入电压	3VDC
Standby current 待机电流	3-10UA
Sensing distance 感应方式	电容式触摸 Capacitive touch
Signal induction 信号距离	5m
Installation 安装方式	嵌装 Built-in

WIRELESS HUMAN BODY INFRARED SENSOR SWITCH

圆形无线人体红外感应开关（升级版本）



产品特点 CHARACTERISTICS

- 无需布线，便捷安装；
- 365 天超长续航，纽扣电池简单更换；
- 人体感应发射信号，实现无线操控；
- 10 米内按开关键遥控灯光亮度及色温；
- 符合安全，环保 RoHS。

- Wireless.
- Over 365 days ultra-long life battery,easy to assemble.
- Body infrared sensor, wireless switch.
- Safe and stable, meet standard of RoHS.
- Sensing range within 10m, adjustable light luminance and color temperature.

安装说明 INSTALLATION INSTRUCTIONS

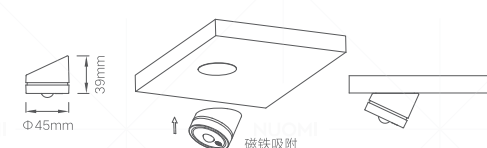

技术参数 TECHNICAL DETAILS

Item No. 型号	12221002
Size (mm) 尺寸	Φ45X40mm
Input voltage 输入电压	3VDC
Standby current 待机电流	3-10UA
Sensing distance 感应方式	热释电红外线感应 body infrared sensor
Sensing distance 感应距离	1-3m
Installation 感应延时	30 秒 seconds
Installation 安装方式	磁吸明装 magnetic surface mounted

WIRELESS DOUBLE DOOR CONTROL

无线双门控



产品特点 CHARACTERISTICS

- 无需布线，便捷安装；
- 365 天超长续航，纽扣电池简单更换；
- 门控 & 手扫感应发射信号实现无线操控；
- 符合安全，环保 RoHS。

- Over 365 days ultra-long life button battery,easy to assemble.
- Door control and hand sweep sensor wireless switch.
- Safe and stable, meet standard of RoHS.

安装说明 INSTALLATION INSTRUCTIONS

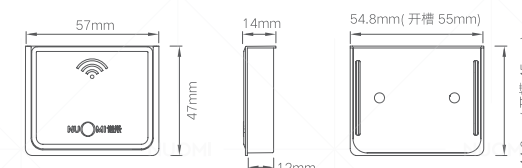

技术参数 TECHNICAL DETAILS

Item No. 型号	12281008
Size (mm) 尺寸	L50xW46xH12mm
Color 颜色	黑色 Black
Input voltage 输入电压	3VDC
Operating current 工作电流	3~10uA
Sensing distance 感应距离	20~40mm
Signal induction 信号距离	5m
Installation 安装方式	明装 / 嵌装 Surface mounted / Built-in

DOOR CONTROL & HAND-SWEEP SENSOR SWITCH

门控 & 手扫感应信号开关



产品特点 CHARACTERISTICS

- 手扫 + 门控功能模式，外壳开小圆孔牙签轻压微动开关切换；
- 采用红外线信号控制灯光；
- 符合安全，环保 RoHS；
- 分离式可拆卸设计，检修方便。

- Door control and hand sweep sensor press small hole with stick to trigger switch.
- Safe and stable, meet standard of RoHS.
- Infrared induction sensor.
- Separateting dismountable structure design, convenient maintenance.

安装说明 INSTALLATION INSTRUCTIONS

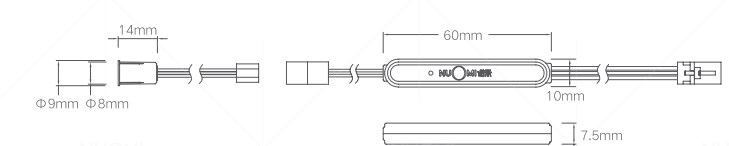

技术参数 TECHNICAL DETAILS

Item No. 型号	12222007
Size (mm) 尺寸	Φ8x14mm (线长: 1m)
Color 颜色	感应头太郎灰，主体哑黑 Highclass grey / Matte black
Input voltage 输入电压	DC12-24V
Sensing distance 感应距离	手扫 hand sweep 5-8CM 门控 door control 3-5CM
Installation 安装方式	明装 / 嵌装 (开孔 hole Φ 8mm) Surface mounted / Built-in

DOOR CONTROL & HAND SWEEP SENSORY POWER SWITCH

门控 + 手扫感应功率开关



产品特点 CHARACTERISTICS

- 红外线感应模式；
 - 采用进口高质量红外光电传感器；
 - 具备门控 & 手扫功能，用牙签轻压外壳小孔开关转换；
 - 分离式可拆卸设计，检修方便。
- High quality imported infrared photoelectric sensor.
 - Convenient switching of door control & hand-sweep control.
 - Separateting dismountable structure design, convenient maintenance.

安装说明 INSTALLATION INSTRUCTIONS

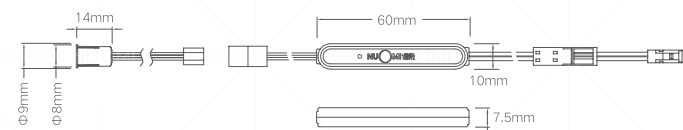

技术参数 TECHNICAL DETAILS

Item No. 型号	12222008
Size (mm) 尺寸	Φ8x14mm
Color 颜色	感应头太郎灰，主体哑黑 Highclass grey / Matte black
Input voltage 输入电压	DC12-24V
Output current 输出功率	36W
Sensing distance 感应距离	手扫 hand sweep 5-8CM 门控 door control 3-5CM
Installation 安装方式	明装 / 嵌装 (开孔 hole φ 8mm) Surface mounted / Built-in

DOUBLE CONTROL OF DOOR SENSOR SWITCH(3P)

双门控信号开关 (3 拼线)



产品特点 CHARACTERISTICS

- 双门控开关，开第一道门亮灯，关第二道门灭灯；
 - 红外线感应发射信号；
 - 符合安全，环保 RoHS；
 - 分离式可拆卸设计，检修方便。
- Double control of door, lighting up while first door open, light goes off while second door closes.
 - Safe and stable, meet standard of RoHS.
 - Wireless control through infrared.
 - Separateting dismountable structure design, convenient maintenance.

安装说明 INSTALLATION INSTRUCTIONS

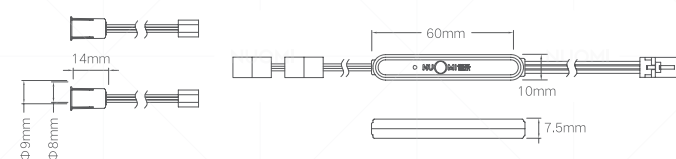

技术参数 TECHNICAL DETAILS

Item No. 型号	12222009
Size (mm) 尺寸	Φ8x14mm
Color 颜色	感应头太郎灰，主体哑黑 Highclass grey / Matte black
Input voltage 输入电压	DC12-24V
Sensing distance 感应距离	门控 door control 3-5CM
Installation 安装方式	明装 / 嵌装 (开孔 hole φ 8mm) Surface mounted / Built-in

DOUBLE CONTROL OF DOOR POWER SWITCH(2P)

双门控感应功率开关 (2 拼线)



产品特点 CHARACTERISTICS

- 双门控开关，开第一道门亮灯，关第二道门灭灯；
 - 材质 ABS；
 - 红外线感应模式开关功能；
 - 分离式可拆卸设计，检修方便。
- Double control of door, lighting up while first door open, light goes off while second door closes.
 - Material: ABS.
 - Infrared sensor switch.
 - Separateting dismountable structure design, convenient maintenance.

安装说明 INSTALLATION INSTRUCTIONS

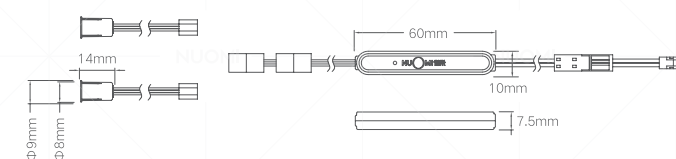

技术参数 TECHNICAL DETAILS

Item No. 型号	12222010
Size (mm) 尺寸	Φ8x14mm
Color 颜色	感应头太郎灰，主体哑黑 Highclass grey / Matte black
Input voltage 输入电压	DC12-24V
Output current 输出功率	36W
Sensing distance 感应距离	门控 door control 3-5CM
Installation 安装方式	明装 / 嵌装 (开孔 hole φ 8mm) Surface mounted / Built-in

TOUCH SENSOR SIGNAL SWITCH

触摸感应信号开关



产品特点 CHARACTERISTICS

- 电容式触摸感应开关，可无极调光；
 - 材质 ABS；
 - 有断电记忆。
- Capacitive touch sensor switch, lighting stepless adjustable.
 - Material: ABS.

安装说明 INSTALLATION INSTRUCTIONS

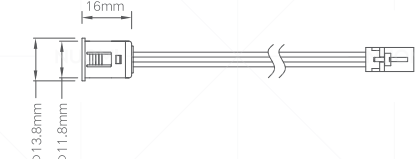

技术参数 TECHNICAL DETAILS

Item No. 型号	12222004
Size (mm) 尺寸	Φ12x16mm
Color 颜色	黑色 Black
Input voltage 输入电压	DC12-24V
Sensing distance 感应距离	电容式触摸感应
Installation 安装方式	明装 / 嵌装 (开孔 hole φ 10mm) Surface mounted / Built-in

HUMAN BODY INFRARED SENSOR SIGNAL SWITCH

人体红外感应信号开关



产品特点 CHARACTERISTICS

- 红外线感应模式开关功能；
- 材质 ABS；
- 抗干扰强，输出长 30 秒。
- Infrared sensor switch.
- Material: ABS.
- Strong anti-interference capacity, output over 30 seconds.

安装说明 INSTALLATION INSTRUCTIONS

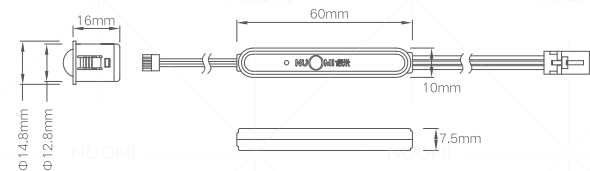

技术参数 TECHNICAL DETAILS

Item No. 型号	12222005
Size (mm) 尺寸	Φ13x17mm
Color 颜色	黑色 Black
Input voltage 输入电压	DC12-24V
Sensing distance 感应距离	1-3m 米
Delay 延长亮灯时间	30 秒
Installation 安装方式	明装 / 嵌装 (开孔 hole Φ 13mm) Surface mounted / Built-in

WIRELESS CONTROL BOX FOR POWRR SOURCE

电源无线控制盒



产品特点 CHARACTERISTICS

- 触摸感应和无线接收均实现灯具的开关与调光调色温；
- 状态指示灯：双色（红色 / 绿色）；
- 材质 PC FR4。
- Touche sensor and wireless receiving control switch.
- Adjust brightness and color temperature.
- Status light: two colors(red/brown).
- Material: PC FR4.

安装说明 INSTALLATION INSTRUCTIONS

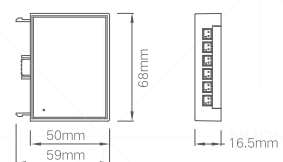

技术参数 TECHNICAL DETAILS

Item No. 型号	12281001
Size (mm) 尺寸	59x68x16.5mm
Color 颜色	黑色 Black
Input voltage 输入电压	12VDC
Output current 输出功率	100W
Antenna 天线	板载或内置 PCB 天线 onboard or internal PCB wire
Installation 传输距离	< 10M 米 (空旷 spacious)

WIRELESS CONTROL BOX FOR POWRR SOURCE (VOICE CONTROL)

电源无线控制盒（语音控制）



产品特点 CHARACTERISTICS

- 触摸感应和 WIFI 天猫精灵语音无线接收均实现灯具的开关与调光调色温；
- 状态指示灯：双色（红色 / 绿色）；
- 材质 PC FR4。
- Touch sensing and Tmall Genie control light on and off, adjust brightness and color temperature.
- Status light: two colors(red/brown).
- Material: PC FR4.

安装说明 INSTALLATION INSTRUCTIONS

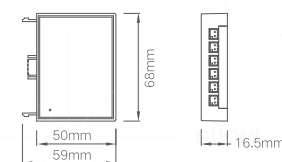

技术参数 TECHNICAL DETAILS

Item No. 型号	12281002
Size (mm) 尺寸	59x68x16.5mm
Color 颜色	黑色 Black
Input voltage 输入电压	12VDC
Output current 输出功率	100W
Antenna 天线	板载或内置 PCB 天线
Installation 传输距离	< 10M 米 (空旷)

WIRELESS CONTROL BOX FOR POWRR SOURCE (VOICE CONTROL)

单色温电源无线控制盒



产品特点 CHARACTERISTICS

- 可同时控制三个电源；
- 材质 PC FR4。
- Touch sensing and Tmall Genie control light on and off, adjust brightness and color temperature.
- Status light: two colors(red/brown).
- Material: PC FR4.

安装说明 INSTALLATION INSTRUCTIONS

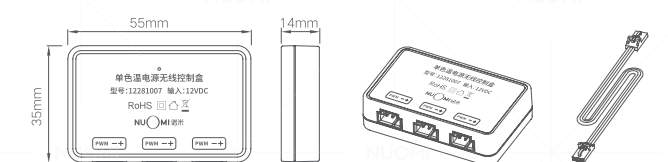

技术参数 TECHNICAL DETAILS

Item No. 型号	12281007
Size (mm) 尺寸	55x35x9mm
Color 颜色	黑色 Black
Antenna 天线	板载或内置 PCB 天线
Installation 传输距离	< 10M 米 (空旷)

SIGNAL JUNCTION BOX

信号分线盒



产品特点 CHARACTERISTICS

- 支持各种有线感应开关，集控五路输出端口
- 符合安全，环保 ROHS，无污染标准
- 功率 60W 以上电源有一个不受控端口可通过此信号分线盒扩展
- 一个信号开关连接此分线盒可集控该分线盒上五个端口，另有一个端口不受控制可叠加使用

- wire sensor switch, 5 output port
- power over 60W, there is one port out of control for wire distribution extension
- one signal switch connect distribution box to control 5 output port, the left one is out of control for stackable usage.

安装说明 INSTALLATION INSTRUCTIONS

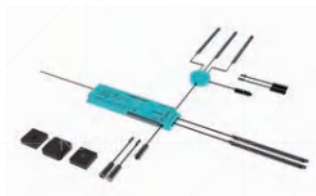

技术参数 TECHNICAL DETAILS

Item No. 型号	12281006
Size (mm) 尺寸	Φ51.5X15.5mm
Color 颜色	黑色 Black
Input voltage 输入电压	12VDC
Output current 输出功率	36W
Output control 输出控制方式	支持有线开关 Wire switch
Material 线材	UL2468 22AWG 1M 杜邦端子 Dupont port

POWER PARALLEL CONNECTION CABLE

电源并联连接线



产品特点 CHARACTERISTICS

- 采用优质材料 ABS 料；
- 线材、端子质量认证，通过 UL 标准认证、RoHS 认证、CE 认证。

- Superior ABS.
- UL,RoHS, CE certificate.

安装说明 INSTALLATION INSTRUCTIONS

技术参数 TECHNICAL DETAILS

Item No. 型号	12282012
Size (mm) 尺寸	1000mm
Ccolor 颜色	哑黑 Matte black
Material 线材	UL2468、22AWG

LED SIX-BIT JUNCTION BOX

LED 六位分线盒



产品特点 CHARACTERISTICS

- 采用优质材料 ABS 料；
- 线材、端子质量认证，通过 UL 标准认证、RoHS 认证、CE 认证。

- Superior ABS.
- UL,RoHS, CE certificate.

安装说明 INSTALLATION INSTRUCTIONS

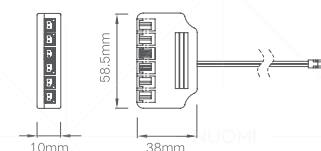

技术参数 TECHNICAL DETAILS

Item No. 型号	12281004
Size (mm) 尺寸	1M
Color 颜色	黑色 Black
Material 线材	UL2468、22AWG

LED THREE-BIT JUNCTION BOX

LED 三位分线盒



产品特点 CHARACTERISTICS

- 采用优质材料 ABS 料；
- 线材、端子质量认证，通过 UL 标准认证、RoHS 认证、CE 认证。

- Superior ABS.
- UL,RoHS, CE certificate.

安装说明 INSTALLATION INSTRUCTIONS

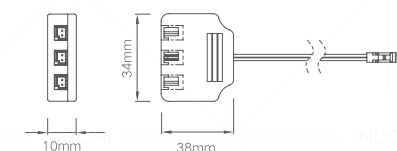

技术参数 TECHNICAL DETAILS

Item No. 型号	12281003
Size (mm) 尺寸	1M
Color 颜色	黑色 Black
Material 线材	UL2468、22AWG

LED EXTENSION WIRE

LED 延长线



产品特点 CHARACTERISTICS

- 采用优质材料 ABS 料；
- 线材、端子质量认证，通过 UL 标准认证、RoHS 认证、CE 认证。
- Superior ABS.
- UL,RoHS, CE certificate.

技术参数 TECHNICAL DETAILS

Item No. 型号	12282001
Size (mm) 尺寸	2M
Color 颜色	黑色 Black
Material 线材	UL2468、22AWG、2pin

SIGNAL EXTENSION CORD

信号延长线



产品特点 CHARACTERISTICS

- 采用优质材料 ABS 料；
- 线材、端子质量认证，通过 UL 标准认证、RoHS 认证、CE 认证。
- Superior ABS.
- UL,RoHS, CE certificate.

技术参数 TECHNICAL DETAILS

Item No. 型号	12282002
Size (mm) 尺寸	2M
Color 颜色	黑色 Black
Material 线材	UL2468、22AWG、3pin

UNIVERSAL PLUG WIRE

L813 公插头线（杜邦端子）



产品特点 CHARACTERISTICS

- 采用优质材料 ABS 料；
- 线材、端子质量认证，通过 UL 标准认证、RoHS 认证、CE 认证。
- Superior ABS.
- UL,RoHS, CE certificate.

技术参数 TECHNICAL DETAILS

Item No. 型号	12282003
Size (mm) 尺寸	L813 黑色公插头线 black plug wire L=1500mm, 尾部开叉 tail split 20mm, 上锡 1.5-2mm
Color 颜色	黑色 Black
Material 线材	UL2468 22AWG 2C 黑色条纹 black strip

SIGNAL EXTENSION CORD

诺米免焊端子线



产品特点 CHARACTERISTICS

- 采用优质材料 ABS 料；
- 线材、端子质量认证，通过 UL 标准认证、RoHS 认证、CE 认证。
- Superior ABS.
- UL,RoHS, CE certificate.

技术参数 TECHNICAL DETAILS

Item No. 型号	12282010
Size (mm) 尺寸	1.5 米
Color 颜色	黑色 Black

UNIVERSAL PLUG WIRE

二合一免焊端子线



产品特点 CHARACTERISTICS

- 采用优质材料 ABS 料；
- 线材、端子质量认证，通过 UL 标准认证、RoHS 认证、CE 认证。
- Superior ABS.
- UL,RoHS, CE certificate.

技术参数 TECHNICAL DETAILS

Item No. 型号	12282013
Size (mm) 尺寸	1.5 米
Color 颜色	黑色 Black

SIGNAL EXTENSION CORD

1283 触摸堵头



产品特点 CHARACTERISTICS

- 采用优质材料 ABS 料；
- 线材、端子质量认证，通过 UL 标准认证、RoHS 认证、CE 认证。
- Superior ABS.
- UL,RoHS, CE certificate.

技术参数 TECHNICAL DETAILS

Item No. 型号	12222013/12222014/12222011
Size (mm) 尺寸	40.5x12x10mm
Color 颜色	波尔多红 / 香槟金 / 太郎灰 Bordeaux red/Champagne golden/Highclass grey
Input voltage 输入电压	12VDC
Output current 输出功率	36W

UNIVERSAL PLUG WIRE

1283 手扫堵头



产品特点 CHARACTERISTICS

- 采用优质材料 ABS 料；
- 线材、端子质量认证，通过 UL 标准认证、RoHS 认证、CE 认证。
- Superior ABS.
- UL,RoHS, CE certificate.

技术参数 TECHNICAL DETAILS

Item No. 型号	12222032
Size (mm) 尺寸	40.5x12x10mm
Color 颜色	哑黑 Matte Black
Input voltage 输入电压	12VDC
Output current 输出功率	36W